

A^uform

Product List Glazed Steel:
Washbasins, washstands and washplaces

Ãform

WP / AG

WT / WT.RX

AB / SB

EB / HB

UB

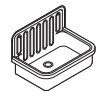
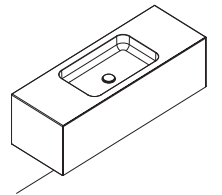
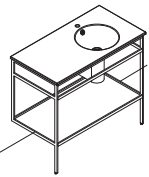
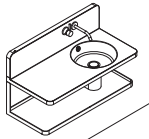
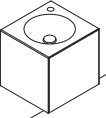
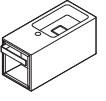
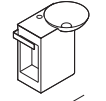
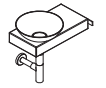
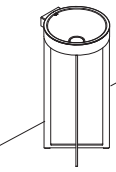
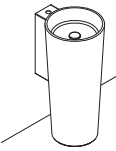
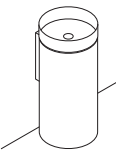
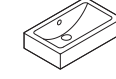
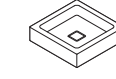
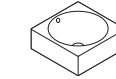
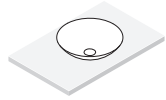
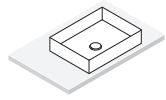
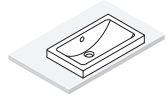
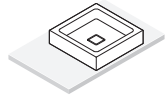
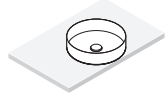
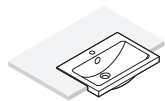
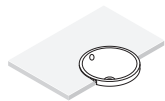
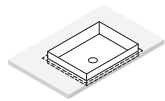
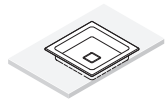
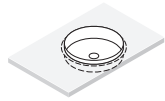
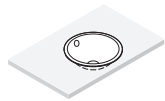
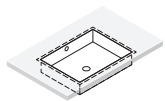
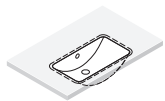
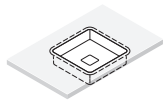
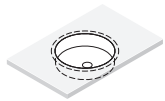
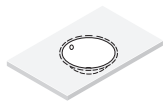

UB – Undermount basins

EB – Built-in basins
HB – Semi-recessed basins

AB – Sit-on basins
SB – Dish basins

WT – Washstands

WP – Washplaces
AG – Bucket sinks

Contents

A~form

General notes	004-005
Novelties / Discontinued articles	006
Article index	007-011

Installation types	012-013
---------------------------	---------

Material

Glazed Steel	014-015
--------------	---------

Individualisation

Made-to-measure washplace	016-017
Individualisation in detail	018-019

Tap fitting and drill holes information	020
--	-----

Technical information

UB Undermount basins	022-037
Overview of basins	023
UB.K, .KE, .SO, .O, .ME, .SR, .R, .RE, .Q, _	024-037

EB Built-in basins	038-063
Overview of basins	039
EB Built-in basins	040-061
EW, EB.S, .K, .KE, .O, .ME, .SR, .R, .RE, .Q	
HB Semi-recessed basins	062
HB.S, .R	

AB Sit-on basins	064-075
Overview of basins	065
AB.KE, .SO, .ME, .SR, .R, .RE, .Q, _	066-075

SB Dish basins	076-081
Overview of basins	077
SB.K, .CO, .O, .SR	078-081

Special glazing	082-097
Overview of basins and washstands	083
Aqua	084-085
Terra	086-087
Bicolor	088-090
Matt black	091-093
Metallic	094-097

WT Washstands	098-127
Washstand overview (WT)	099
WT Floor-standing washstands	100-107
WT Wall-mounted washstands	108-127
WT.RS	108-109
Scopio (WT.CO)	110
WT.IC	111-112
WT.MC	113-114
Fusion.S (WT.XXS)	115-116
WT.QS	117-120

Xplore.S (WT.XS)	121-122
Stream (WT.SR)	123
WT.PR	124-127

WP Washplaces	128-153
Overview of washplaces made from	
glazed steel (WP)	129
Insert (WP.Insert)	130-131
Piccolo Novo (WP.PN/SET.WP.PN)	132-133
Fusion.S (WP.XXS)	134
Xplore.S (WP.XS)	135
Steel19 (WP.S19.1, WP.S19.L1/.L2)	136-138
Work.Frame (WP.WF)	139-141
Accessories Work.Frame (SV.WF)	142-143

Overview of washplaces with cabinets (WP)	145
Folio (WP.Folio)	146-151
Accessories Folio	152-153

Sets	154-159
Overview shelves	155
Set.AB.KE, .SB.K, .WT.XS, .WP.Insert	156-159

AG Bucket sinks	160-163
------------------------	---------

Assist shelf system	164-169
Overview shelves	165
Shelves	166-169

Mirrors	170-177
Overview of design mirrors SP.FR	171
Design mirrors SP.FR	172-175
Mirror SP.	176-177

Accessories	178-181
For basins, washstands, and washplaces	

Spare parts	182-183
For basins, washstands, and washplaces	

Mounting and connection measurements	184-197
Terms of Trading and Delivery	198-199
Overview colors	201

General notes

Alape stands for holistic washplace solutions and emphasises this with the addition of attractive washplaces for small bathrooms, to the portfolio. These are selected basins and washstands in a set with the new Alape Rivo tap. In the SETS chapter you will find the six washplaces, each with the tap in chrome and matt black.

Novelties | Current range

From page 6 you will find a list of our novelties, the discontinued articles and the article index of our current portfolio.

Price reduction

We would like to point out that over 40% of all washbasins and washstands have been reduced in price. The articles in question are marked in the separate article index list.

Service team

Our service team provides partner-like and competent support. You can reach the team on +49 (0)5321.558-111 or service@alape.de.

Contact details

You can find national and international contact details on our homepage at www.alape.com/en/service.

Manufacturer guarantee

We offer a manufacturer's guarantee of 25 years for Alape basins and washstands made of glazed steel.

A manufacturer's guarantee of 5 years applies to the Alape fittings.

You will find detailed information about our warranty conditions at www.alape.com/en/service.

Care & Maintenance notes

A prerequisite for the guarantee is the proper use and care of the product. You can find out more about product care at www.alape.com/en/service.

Visit our new service site

www.alape.com/en/service



General notes

Variable installation types for basins

Alape offers an extensive range with regards to systematic variety. It includes undermount-, built-in and semi-recessed basins, as well as sit-on and dish basins. On page 12 you will find information about the benefits of every installation type.

Fittings information

Please refer to the price list in the product descriptions for information on the optimum water impact area on the basin mold.

Colours

Our basins, washbasins and washing plates made of glazed steel are by default in white surface. On page 201 you will find an overview of which series are for surcharge also available in the current glossy and matt colours. In addition, in the chapter Special glazes you will find selected basins and washstands in a wide variety of colors and surfaces.

Technical Data

We have collated all important information for you as a planning professional at www.alape.com. Here you can find more extensive information and technical details for each product, such as CAD data, descriptive texts or declarations of performance.

BIM data now available

The top 50 items and their variants, which total to around 140 items, are now available as BIM data. They range from simple built-in basins to complex washing area solutions. The data will continue to expand in the future. The data is available in English (www.bimobject.com/en/alape) and German (www.bimobject.com/de/alape) and is offered in detail levels (LOD) 100, 200 and 300. Additionally, they are available in all common formats such as the international exchange format IFC, and are therefore available for all major software providers - e.g. ArchiCad or AutoCad.

Novelties

Article	Name	Finish faucet	Page
Sets			
0633 001 000	SET.AB.KE325	Chrome	156
0633 002 000	SET.AB.KE325	Matt black	156
0634 001 000	SET.AB.KE375	Chrome	156
0634 002 000	SET.AB.KE375	Matt black	157
0635 001 000	SET.SB.K300.GS	Chrome	157
0635 002 000	SET.SB.K300.GS	Matt black	157
0636 001 000	SET.SB.K360.GS	Chrome	158
0636 002 000	SET.SB.K360.GS	Matt black	158
0637 001 000	SET.WP.Insert1	Chrome	159
0637 002 000	SET.WP.Insert1	Matt black	159
0639 001 000	SET.WT.XS500H.L	Chrome	158
0639 002 000	SET.WT.XS500H.L	Matt black	159

Discontinued items

Article	Name	Description
Basins and washstands		
1100 000 000	AG.Stahlform505	Bucket sink
2023 503 000	EB.KE325	Built-in basin
3000 200 000	AB.K325.2	Sit-on basin
3002 200 000	AB.K400.2	Sit-on basin
3004 200 000	AB.K400H.2	Sit-on basin
3006 200 000	AB.K450.2	Sit-on basin
3008 000 000	AB.K450H.2	Sit-on basin
4102 000 000	WT.RE1000H.L	Washstand
4104 000 000	WT.RE1000H.R	Washstand
4105 000 000	WT.RE800H	Washstand
4261 200 000	WT.GR800H	Washstand
4275 000 000	WT.QS450	Washstand
4276 000 000	WT.QS450H	Washstand
4278 000 000	WT.QS450HX	Washstand
4287 200 000	WT.GR1250H	Washstand
4288 200 000	WT.GR1250H.L	Washstand
4289 200 000	WT.GR1250H.R	Washstand
4502 000 000	WT.RX325K	Floor-standing washstand
4802 000 000	WT.RX325QS	Floor-standing washstand

Litghting / Mirrors

8011 001 978	LE.2	Light
8012 000 978	LE.3	Light
6736 000 899	SP.2	Mirror 800 x 800 mm
6736 001 899	SP.2	Mirror 1000 x 800 mm
6737 002 899	SP.2	Mirror 1200 x 800 mm

Drawer dividers for Folio waschplaces

8400 057 667	FU.H358.1	Drawer divider
8400 058 667	FU.H358.2	Drawer divider
8400 059 667	FU.H408.1	Drawer divider
8400 060 668	FU.TI.1	Tissuebox
8400 061 668	FU.BX.1	Tidying box
8400 062 668	FU.BX.2	Drawer divider
8400 063 669	FU.TB.1	Shelf

Article index

Article	Name	Page	Article	Name	Page
Undermount basins			2101 000 000	EB .0525	051
2030 700 000	UB .K325	024	2101 100 000	EB .0525	051
2031 700 000	UB .K400	024	2102 000 000	EB .0500H	050
2032 700 000	UB .K450	025	2102 100 000	EB .0500H	050
2110 700 000	UB .0425	031	2104 000 000	EB .0600H	052
2111 700 000	UB .0525	031	2104 100 000	EB .0600H	052
2250 700 000	UB .R585	035	2201 000 000	EB .R585	057
2251 700 000	UB .R800	036	2201 100 000	EB .R585	057
2255 700 000	UB .SR650	035	2202 000 000	EB .R585H	056
2258 500 000	UB .RE700 .4	036	2202 100 000	EB .R585H	056
2312 500 000	UB .Q450	037	2203 000 000	EB .R800	059
3223 501 000	UB .KE325	026	2203 200 000	EB .R800	059
3223 504 000	UB .KE325	026	2204 000 000	EB .R800H	058
3224 501 000	UB .KE375	027	2204 200 000	EB .R800H	058
3224 504 000	UB .KE375	027	2207 000 000	EB .RE700 .4	060
3225 501 000	UB .KE400	028	2208 000 000	EB .RE700H .2	060
3225 504 000	UB .KE400	028	2218 500 000	EB .SR650	055
3226 701 000	UB .ME500	032	2218 700 000	EB .SR650	055
3226 704 000	UB .ME500	032	2219 600 000	EB .SR650H	054
3227 701 000	UB .ME750	033	2219 800 000	EB .SR650H	054
3227 704 000	UB .ME750	033	2226 503 000	EB .ME500	053
3228 701 000	UB .ME1000	034	2227 503 000	EB .ME750	053
3228 704 000	UB .ME1000	034	2302 000 000	EB .Q450	061
3505 501 000	UB .S0450 .1	029	2303 000 000	EB .Q450H	061
3505 504 000	UB .S0450 .1	029	2406 000 000	EB .S450H	042
3506 501 000	UB .S0450 .2	030	2406 100 000	EB .S450H	042
3506 504 000	UB .S0450 .2	030	Semi recessed basins		
Built-in basins			2700 000 000	HB .R585H	062
2000 000 000	EB .K325	043	2900 000 000	HB .S450H	062
2000 200 000	EB .K325	043	Sit-on basins		
2001 000 000	EB .K400	045	3202 000 000	AB .R585H .1	072
2001 100 000	EB .K400	045	3205 000 000	AB .R585 .1	072
2002 000 000	EB .K450	047	3206 200 000	AB .R800H	073
2002 100 000	EB .K450	047	3207 200 000	AB .R800	073
2003 000 000	EB .K400H	044	3208 000 000	AB .RE700 .4	074
2003 200 000	EB .K400H	044	3209 000 000	AB .RE700H .2	074
2004 000 000	EB .K450H	046	3212 000 000	AB .ME500	069
2004 100 000	EB .K450H	046	3213 000 000	AB .ME750	069
2005 000 000	EW 3	040	3214 000 000	AB .ME1000	070
2005 100 000	EW 3	040	3220 000 000	AB .KE325	066
2018 000 000	EW 3 .2	041	3221 000 000	AB .KE375	066
2018 100 000	EW 3 .2	041	3222 000 000	AB .KE400	067
2024 503 000	EB .KE375	048	3230 700 000	AB .SR650	071
2025 503 000	EB .KE400	048	3231 600 000	AB .SR650H	071
2100 000 000	EB .0425	049	3302 000 000	AB .Q450 .1	075
2100 100 000	EB .0425	049			

Article index

Article	Name	Page	Article	Name	Page
3304 000 000	AB . Q450H . 1	075	3902 000 084	SB . Terra450	087
3503 000 000	AB . S0450 . 1	068	3902 000 091	SB . Aqua450	085
3509 000 000	AB . S0400 . 1	068	3902 000 092	SB . Aqua450	085
			3902 000 093	SB . Aqua450	085
Dish basins			4503 000 190	WT . RX400K	096
3500 000 000	SB . K300 . GS	078	4506 500 180	WT . RX400 . KE	090
3501 000 000	SB . K360 . GS	078			
3502 000 000	SB . K450 . GS	079	Washstands		
3507 500 000	SB . SR650	080	4200 000 000	WT . PR585	124
3508 500 000	SB . C0375	079	4201 000 000	WT . PR585H	124
3520 000 000	SB . 0700 . GS	080	4203 000 000	WT . PR800H	125
			4203 300 000	WT . PR800	125
Special glazes			4205 000 000	WT . PR800H . L	126
2031 500 190	UB . K400	094	4205 300 000	WT . PR800 . L	126
2111 500 190	UB . 0525	094	4207 000 000	WT . PR800H . R	127
3222 000 180	AB . KE400	088	4207 300 000	WT . PR800 . R	127
3222 000 240	AB . KE400	091	4228 000 000	WT . MC450H	113
3501 000 180	SB . K360 . GS	089	4230 000 000	WT . MC800H	113
3501 000 190	SB . K360 . GS	096	4231 000 000	WT . MC800H . L	114
3501 000 240	SB . K360 . GS	092	4232 000 000	WT . MC800H . R	114
3503 000 180	AB . S0450 . 1	089	4236 200 000	WT . IC325H	111
3503 000 190	AB . S0450 . 1	095	4238 200 000	WT . IC600H	111
3503 000 240	AB . S0450 . 1	092	4239 200 000	WT . IC600H . L	112
3509 000 180	AB . S0400 . 1	088	4240 200 000	WT . IC600H . R	112
3509 000 190	AB . S0400 . 1	095	4270 000 000	WT . QS325	117
3509 000 240	AB . S0400 . 1	091	4271 000 000	WT . QS325X	118
3521 500 081	SB . SR650	087	4273 000 000	WT . QS525 . L	119
3521 500 082	SB . SR650	087	4274 000 000	WT . QS525 . R	120
3521 500 083	SB . SR650	087	4277 000 000	WT . QS325H	117
3521 500 084	SB . SR650	087	4279 000 000	WT . QS525H . L	118
3521 500 240	SB . SR650	093	4280 000 000	WT . QS525H . R	119
3900 000 081	SB . Terra300	086	4281 600 000	WT . SR800H . L	123
3900 000 082	SB . Terra300	086	4282 600 000	WT . SR800H . R	123
3900 000 083	SB . Terra300	086	4290 000 000	WT . XS500H . L	121
3900 000 084	SB . Terra300	086	4291 000 000	WT . XS500 . L	121
3900 000 091	SB . Aqua300	084	4292 000 000	WT . XS500H . R	122
3900 000 092	SB . Aqua300	084	4293 000 000	WT . XS500 . R	122
3900 000 093	SB . Aqua300	084	4295 000 000	WT . XXS450H . L	115
3901 000 081	SB . Terra360	086	4296 000 000	WT . XXS450 . L	115
3901 000 082	SB . Terra360	086	4297 000 000	WT . XXS450H . R	116
3901 000 083	SB . Terra360	086	4298 000 000	WT . XXS450 . R	116
3901 000 084	SB . Terra360	086	4500 000 000	WT . RX400KH	102
3901 000 091	SB . Aqua360	084	4501 000 000	WT . RX325K	102
3901 000 092	SB . Aqua360	084	4503 000 000	WT . RX400K	103
3901 000 093	SB . Aqua360	084	4504 000 000	WT . RX400K	107
3902 000 081	SB . Terra450	087	4505 500 000	WT . RX325 . KE	105
3902 000 082	SB . Terra450	087	4506 500 000	WT . RX400 . KE	105
3902 000 083	SB . Terra450	087	4507 500 000	WT . RX400 . CO	104

Article index

Article	Name	Page	Article	Name	Page
4507 800 000	WT.RX400H.CO	104	5157 511 000	WP.Folio6	149
4508 500 000	WT.RX400.CU	101	5157 513 000	WP.Folio6	149
4508 800 000	WT.RX400H.CU	101	5157 514 000	WP.Folio6	149
4509 500 240	WT.RX400.CR	100	5157 516 000	WP.Folio6	149
4509 800 240	WT.RX400H.CR	100	5157 810 000	WP.Folio5	149
4801 000 000	WT.RX325QS	106	5157 811 000	WP.Folio5	149
4804 000 000	WT.RX450QS	106	5157 813 000	WP.Folio5	149
4805 000 000	WT.RX450QS	107	5157 814 000	WP.Folio5	149
5041 000 000	WT.RS325	108	5157 816 000	WP.Folio5	149
5042 500 000	WT.CO400	110	5158 510 000	WP.Folio8	150
5042 800 000	WT.CO400H	110	5158 511 000	WP.Folio8	150
5052 000 000	WT.RS400	108	5158 513 000	WP.Folio8	150
5054 000 000	WT.RS450	109	5158 514 000	WP.Folio8	150
			5158 516 000	WP.Folio8	150
			5158 810 000	WP.Folio7	150
			5158 811 000	WP.Folio7	150
			5158 813 000	WP.Folio7	150
			5158 814 000	WP.Folio7	150
			5158 816 000	WP.Folio7	150
			5159 510 000	WP.Folio10	151
			5159 511 000	WP.Folio10	151
			5159 513 000	WP.Folio10	151
			5159 514 000	WP.Folio10	151
			5159 516 000	WP.Folio10	151
			5159 810 000	WP.Folio9	151
			5159 811 000	WP.Folio9	151
			5159 813 000	WP.Folio9	151
			5159 814 000	WP.Folio9	151
			5159 816 000	WP.Folio9	151
			5161 510 000	WP.Folio12	146
			5161 511 000	WP.Folio12	146
			5161 513 000	WP.Folio12	146
			5161 514 000	WP.Folio12	146
			5161 516 000	WP.Folio12	146
			5161 810 000	WP.Folio11	146
			5161 811 000	WP.Folio11	146
			5161 813 000	WP.Folio11	146
			5161 814 000	WP.Folio11	146
			5161 816 000	WP.Folio11	146
			5241 000 000	WP.INSERT1	130
			5241 000 110	WP.INSERT1	130
			5242 000 000	WP.INSERT2	130
			5242 000 110	WP.INSERT2	130
			5245 000 000	WP.INSERT5	131
			5245 000 110	WP.INSERT5	131
			5256 000 000	WP.PN1	132
			5256 000 081	WP.PN1	132
			5256 000 083	WP.PN1	132

Washplaces

Article index

Article	Name	Page	Article	Name	Page
5256 000 084	WP . PN1	132	8270 321 331	AS . 400 . HT . R	167
5257 000 000	WP . PN2	132	8270 321 980	AS . 400 . HT . R	167
5257 000 081	WP . PN2	132	8271 000 331	AS . 600 . S	166
5257 000 083	WP . PN2	132	8271 000 980	AS . 600 . S	166
5257 000 084	WP . PN2	132	8271 140 331	AS . 600 . HT	166
5260 000 000	WP . S19 . 1	136	8271 140 980	AS . 600 . HT	166
5261 000 000	WP . S19L . 1	137	8272 000 331	AS . 800 . S	166
5262 000 000	WP . S19L . 2	138	8272 000 980	AS . 800 . S	166
5266 000 000	WP . S19 . 1R	136	8274 111 981	AS . 134 . L02	168
5267 000 000	WP . S19L . 1R	137	8274 111 982	AS . 134 . L02	168
5268 000 000	WP . S19L . 2R	138	8274 112 981	AS . 225 . L03	168
5270 000 000	WP . WF100 . 1	141	8274 112 982	AS . 225 . L03	168
5271 000 000	WP . WF20 . 1	139	8274 170 981	AS . 160 . TPH	168
5272 000 000	WP . WF20 . 2	139	8274 170 982	AS . 160 . TPH	168
5273 000 000	WP . WF20 . 3	140			
5274 000 000	WP . WF20 . 4	140			
Sets			Design mirrors		
0633 001 000	SET . AB . KE325	156	6740 001 331	SP . FR375 . S1	172
0633 002 000	SET . AB . KE325	156	6740 001 899	SP . FR375 . S1	172
0634 001 000	SET . AB . KE375	156	6741 001 331	SP . FR450 . S1	172
0634 002 000	SET . AB . KE375	157	6741 001 899	SP . FR450 . S1	172
0635 001 000	SET . SB . K300 . GS	157	6742 001 331	SP . FR500 . S1	172
0635 002 000	SET . SB . K300 . GS	157	6742 001 899	SP . FR500 . S1	172
0636 001 000	SET . SB . K360 . GS	158	6743 001 331	SP . FR600 . S1	173
0636 002 000	SET . SB . K360 . GS	158	6743 001 899	SP . FR600 . S1	173
0637 001 000	SET . WP . Insert1	159	6744 001 331	SP . FR600 . R1	174
0637 002 000	SET . WP . Insert1	159	6744 001 899	SP . FR600 . R1	174
0639 001 000	SET . WT . XS500H . L	158	6745 001 331	SP . FR750 . R1	174
0639 002 000	SET . WT . XS500H . L	159	6745 001 899	SP . FR750 . R1	174
			6746 001 331	SP . FR1000 . R1	174
			6746 001 899	SP . FR1000 . R1	174
Bucket sinks			Mirrors		
1200 000 000	AG . Stahlform510Ü	162	6716 000 899	SP . 325	176
1205 000 180	AG . Stahlform510Ü	162	6717 000 899	SP . 450	177
1300 000 000	AG . CONTRA505	162	6719 000 899	SP . 300	176
8901 000 722	Alurost	163	6720 000 899	SP . 300C	176
8902 000 980	UTENSILO	162			
Assist shelves			Accessories For washplaces of the Work.Frame series		
8266 000 671	AS . Box1	167	8112 000 980	SV . WF100 . 1	142
8267 000 671	AS . Box2	167	8112 999 980	SV . WF100 . 1R	143
8270 000 331	AS . 400 . S	166	8113 000 980	SV . WF20 . 1 . 2	142
8270 000 980	AS . 400 . S	166	8113 999 980	SV . WF20 . 1 . 2R	142
8270 000 981	AS . 400 . S	168	8114 000 980	SV . WF20 . 3 . 4	142
8270 000 982	AS . 400 . S	168			
8270 221 331	AS . 400 . HT . L	167	Cupboards of the Folio series		
8270 221 980	AS . 400 . HT . L	167	6323 690 010	HS . F01250 . R	152
			6323 690 011	HS . F01250 . R	152

Article index

Article	Name	Page
6323 690 013	HS . F01250 . R	152
6323 690 014	HS . F01250 . R	152
6323 690 016	HS . F01250 . R	152
6323 990 010	HS . F01250 . L	152
6323 990 011	HS . F01250 . L	152
6323 990 013	HS . F01250 . L	152
6323 990 014	HS . F01250 . L	152
6323 990 016	HS . F01250 . L	152

Accessories for washbasins, washstands and washplaces

8110 000 978	EV . 3	179
8302 000 978	VT . 1	179
8304 000 000	VT . 2	180
8304 000 978	VT . 2	180
8305 000 000	VT . 3	180
8305 000 978	VT . 3	180
8306 000 978	SI . 2	179
8312 000 331	SI . 3	179
8312 000 978	SI . 3	179
8312 000 980	SI . 3	179
8319 000 000	VT . 4	180
8320 000 000	VT . 5	180
8320 000 978	VT . 5	180
8321 000 330	UR . 1	181
8321 000 331	UR . 1	181
8321 000 980	UR . 1	181
9500 280 000	Überlaufgarnitur B.1	181
9500 410 000	Überlaufgarnitur C	181

Spare parts for washbasins, washstands and washplaces

You can find the spare parts on page 182 - 183.

Alape installation procedures

With regards to systematic variety, Alape's extensive range remains unsurpassed. It includes built-in basins, undermount and semi-recessed basins, flush-mounted basins as well as sit-on and dish basins. These small, subtle differences allow Alape to set accents in bathroom design.

UB Undermount basins



Installation from below

Classic undermounting variant; with its integrating character, it creates a harmonious overall impression at the washplace. — Material-specific special sets are not required for assembly. It can be installed in all standard counter top materials and thicknesses.



Undermounting in HPL-coated counter tops

Filigree special solution for installation underneath counter tops coated with HPL (high pressure laminate). — Sealing takes place with a sealing material to be chosen by the fitter. The basin edge is adhered directly under the HPL and the cut-out filled from below with cast resin.



Undermounting basins with 3 mm edge in HPL-coated counter tops

Undermounting basin variant with 3 mm edge directly below the HPL layer. — Sealing takes place with a sealing material to be chosen by the fitter. The basin edge is adhered directly under the HPL and the cut-out filled from below with cast resin.

EB Built-in basins

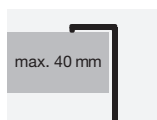

Installation from above

The most traditional and widespread installation solution. Distinctive edge defines the basin above the counter top. — Assembly and sealing take place in a straightforward and fast manner using a polystyrene ring located on the basin edge, supplied adhesive, and in some cases additional mechanical bracket elements. — It can be installed in all modern counter top materials up to a max. thickness of 40 mm.

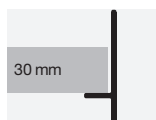

Built-in basins with 3 mm edge

Filigree Alape special solution for basins with 3 mm wall thickness. With a basin edge protruding 25 mm beyond the counter as standard in the series. — Sealing takes place with a sealing material to be chosen by the fitter, which should be coordinated with the counter top in terms of colour. — It can be installed in all mineral-bound, 30 mm-thick counter top materials.

AB / SB Sit-on and dish basins



Traditional sit-on basins

Classic installation variant, lending the basin a dominant character at the washplace. — Classic mechanical assembly using the supplied mounting set. — It can be installed in all standard counter top materials from 12 to 40 mm thickness.

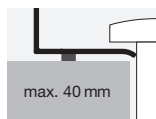

Sit-on basins with 3 mm edge

Filigree basin variant for the sit-on basin with a mere 3 mm-thick edge. A spacer ring under the basin underscores the filigree shape and simplifies cleaning. — Mounting is straightforward thanks to the supplied shaft valve that can be adjusted to the counter thickness flexibly. — It can be installed in all standard counter top materials from 12 to 40 mm thickness.



Unisono
Sit-on basins with 3 mm edge
AB.KE400
ø 400 x 116 mm

Glazed steel: A material with many talents.

With “A” form”, we have gone from producing washing jugs and bowls over 125 years ago to one of the most diverse ranges of basins and washstands in the sanitary sector.

Besides the huge range of variants with regard to design and assembly, our basins and washstands made from glazed steel offer further benefits resulting from the material. In day-to-day use, you benefit from these positive characteristics.



Surface Glazed Steel

In the glaze firing, an almost pore-free surface of glass-smooth quality is created, on which neither microorganisms nor dirt particles can find a hold. In addition, the surface does not become statically charged and does not attract dust. This makes our surfaces very easy to care for and hygienic.

Alape ProShield surface : additional protection against bacteria and fungi

The surface of the glazed steel frees itself from bacteria and fungi thanks to the addition of silver ions. It acts like a protective shield. Our white basins and washstands are equipped with the ProShield surface as standard.

Resistant to impacts, scratches and abrasions

The glaze, a wafer-thin skin up to a maximum of 300 µm, is immune to external influences. Thin and robust, the glaze deals with the day-to-day household challenges thanks to its mechanical resistance. Therefore, it is a rare occurrence for scratch marks, abrasions or flaking to arise.

Colorfast and resistant to UV light

Our basin and washstand colors do not fade, regardless of how intensive your shade of color is. This is due to the specific pigments in the glaze, which do not adopt their final color until the firing process. After this, the glaze is perfectly protected against all types of influences.



Stable shape

Our basins and washstands enjoy a tolerance of +2/-0 millimeters. With intricate manufacturing from the titanium reinforced steel and fired at 830 degrees Celsius, Alape basins always retain their shape and withstand external influences such as varying temperatures and mechanical loads.

Lightness

Traditionally, our basins and washstands have wall thicknesses between 1.5 and 3 millimetres. Therefore, they are significantly lighter than equivalent products made from other materials.

Resistant to heat and cold

The glaze is fired into the steel at 830 degrees Celsius and withstands temperature differences of between -60 and +450 degrees Celsius. Even temperature shocks, in other words sudden effects of heat and cold, cannot harm the material.

Resistant to acids and chemicals

Our glazing has the same acid resistance as glass, meaning that hydrofluoric acid could damage the surface long-term. This is based upon glass-forming oxides, which fuse with the steel during the firing process as a protective coating.



Made-to-measure washplaces

Irrespective of the construction task at hand, we can adjust our products to meet a project's requirements above and beyond the series standard in terms of colour, dimensions and functionality. Our washstands can be practically freely configured in respect of width, depth and height. Owing to their structural design, functional elements can be integrated too, such as rubbish flaps, lotion, cosmetic or paper towel dispensers, and towel holders.

We can implement washplaces in tight or complex room situations, such as close to doors, with oblique sections and notches in the washstand; we are pleased to undertake made-to-measure manufacturing for niches. Even in the case of custom specifications, our basins and washstands always retain their precision with a dimension tolerance of a mere $+2/-0$ millimetre.

Whether it is an extremely small, main or hotel bathroom, semi-public sanitary room or spa area: our abilities go beyond basins and washstands. Combinations with counter tops and furniture programmes form part of our range of services too, as well as realising single or bank designs.

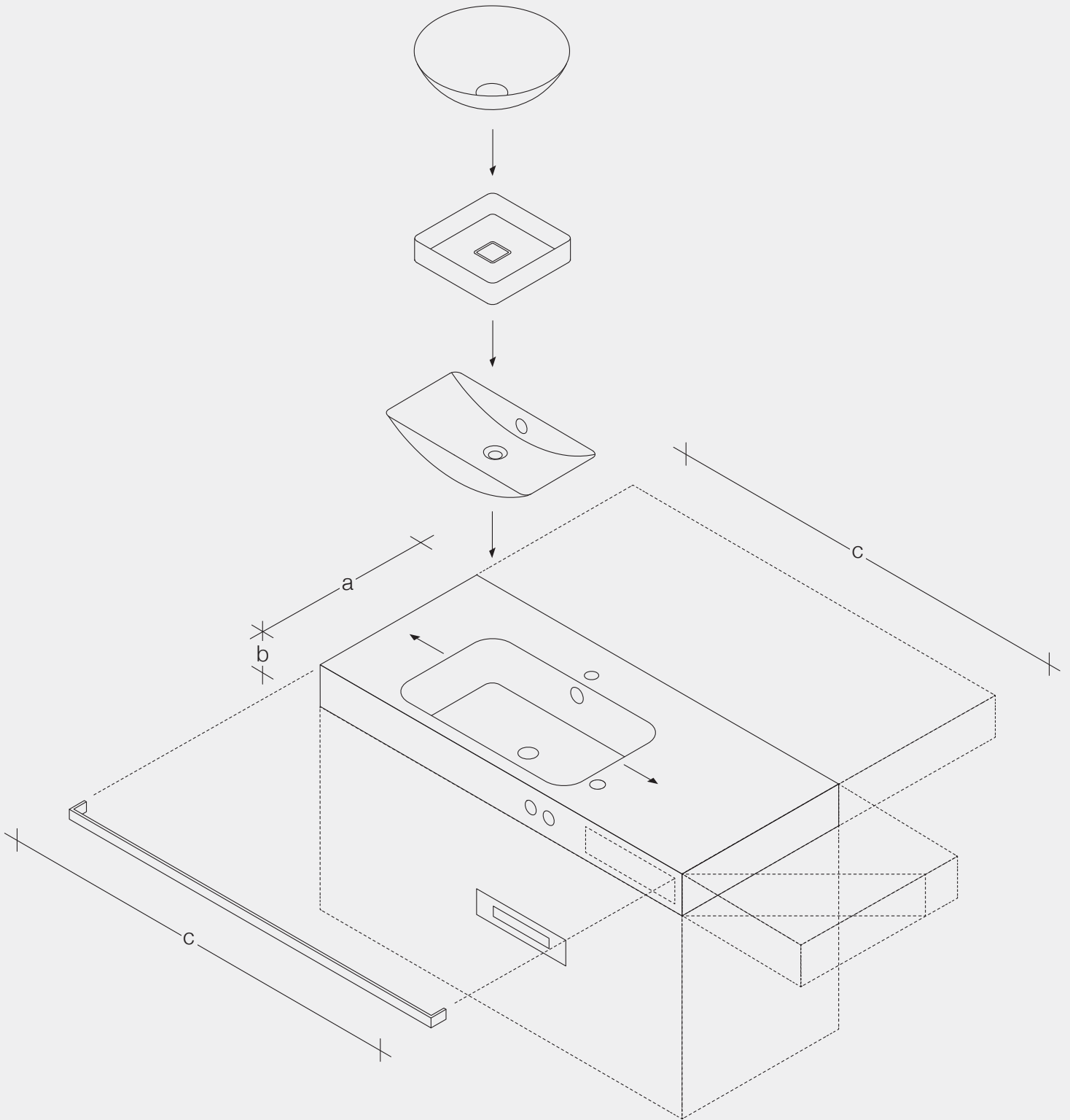

Individualisation in detail

Project-specific solutions for built-in basins

The edge height can be set variably on built-in basins made from 3 mm glazed steel. The standard here is 25 millimetre edge height above the counter top; however, other overhangs can be set with equally exact precision and stress the basin's filigree shape.

Custom-made products

Sit-on basins can be adjusted to meet project-specific requirements in terms of external height and width dimension; this applies to washstands in terms of depth, width and height.

Drill holes

We can provide custom drill holes in basins and washstands in line with a specification. Not only the bore hole's diameter can be varied, but also its position on the washstand or tap area. Additional drill holes can be integrated upon request too and adjusted in terms of position and diameter.

Functional integration

The design-related benefits of glazed steel enable additional functions to be integrated on a straight-forward basis. In this way, paper and cosmetic tissue dispensers can be integrated into washstands or towel holders assembled onto them, for example.

Notches and oblique sections

In complex room situations, tight niches or close to doors, washplaces can be implemented often only with made-to-measure products. Through oblique sections or making notches in corners, we are able to adjust washstands exactly to the millimetre. Therefore, we are able to react together with you to such planning challenges. We can also manufacture fixtures according to your specifications.



**Custom engraving and free colour choice**

Logos or lettering can be engraved to achieve your own custom branding. Our laser engraving is discreet and absolutely lasting in the uppermost glaze layer. We can realise custom colour requests according to RAL right from a quantity of ten basins upwards. According to your specification, our production department can create colour samples from glazed steel for you to choose from and approve.

Adjusting semi-recessed basins

To guarantee a harmonious overall appearance, semi built-in basins can be coordinated precisely in terms of their inner radius to suit the radius of the counter top material. Furthermore, the front skirt's height can be varied.



Tap fitting and drill hole information



Tap fittings with a vertical outlet and aerator provide the optimum flow of water onto the surface below (angle of impact: 90°). We make sure here that the outlet on the stand or wall fitting aligns with the vent in the basin, and that water does not impact to the left or right of the valve cap in the basin. To minimise splashing we also recommend to use a flow restrictor of maximum 7,5l / min. or to reduce the water pressure to maximum 4,5 bar.

With regard to the mounting height of a wall outlet fitting, please observe the respective instructions or recommendations of the manufacturer. The distance between the top edge of the basin and bottom edge of the outlet is normally between 140 to 200 mm.

Please refer to the price list in the product descriptions for information on the optimum water impact area on the basin mould.

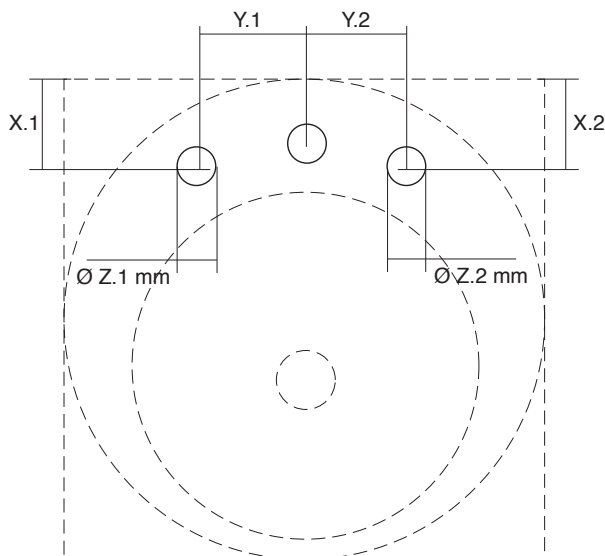

The standard dimensions for tap drill holes is 36 mm according to EN 111. The hole spacing is 100 mm.

All special versions, such as tap hole variants of series products as well as three-hole and lotion dispenser drillings are available on request.

Technical Information

Alape website

For comprehensive information on our A~form product range, please visit the www.alape.com. All product documentation and tender specifications planning data are available for download. Use this database to make product specifications quickly and directly.



















www.alape.com

Undermount basins

UB



Undermount basin
UB . K450
ø 409 x 159mm

Basin width				
325 – 425mm	450 – 585mm	600 – 700mm	750 – 1000mm	
 <p>UB . K325 Mould ø 284mm Page 24</p>	 <p>UB . K450 Mould ø 409mm Page 25</p>			Round
 <p>UB . K400 Mould ø 359mm Page 24</p>	 <p>UB . S0450 . 1 Mould ø 456/444mm Page 29</p>			
 <p>UB . KE325 Mould ø 319mm Page 26</p>	 <p>UB . S0450 . 2 Mould ø 456/444mm Page 30</p>			
 <p>UB . KE375 Mould ø 369mm Page 27</p>				
 <p>UB . KE400 Mould ø 394mm Page 28</p>				
 <p>UB . 0425 Mould 379 x 281mm Page 31</p>	 <p>UB . 0525 Mould 481 x 383mm Page 31</p>			Oval
	 <p>UB . Q450 Mould 371 x 371mm Page 37</p>	 <p>UB . SR650 Mould 609 x 359mm Page 35</p>	 <p>UB . ME750 Mould 754 x 379mm Page 33</p>	Square and rectangular
	 <p>UB . ME500 Mould 504 x 379mm Page 32</p>	 <p>UB . RE700 . 4 Mould 645 x 343mm Page 36</p>	 <p>UB . R800 Mould 703 x 360mm Page 36</p>	
	 <p>UB . R585 Mould 507 x 273mm Page 35</p>		 <p>UB . ME1000 Mould 1004 x 379mm Page 34</p>	

Undermount basins – K-series

Cut-out dimensions: Download www.alape.com

UB . K325



Undermount basin, round, Ø 284 mm, height 110 mm, glazed steel, without tap hole, with overflow, included fixing set, overflow set

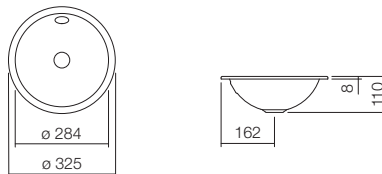

Art. No.

white, ProShield

2030 700 000

Version

Without overflow
Glossy, matt, special colour

Fittings information

Impact area approx. 85 – 115 mm from rear edge of basin.
For parameters, see page 20.

Recommended miscellaneous

Bottle trap, Sl.2
Bottle trap, Sl.3
Drain valve, VT.1

Art. No.

8306 000 978
8312 000 978
8302 000 978

UB . K400



Undermount basin, round, Ø 359 mm, height 140 mm, glazed steel, without tap hole, with overflow, included fixing set, overflow set

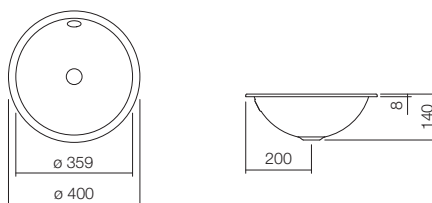

Art. No.

white, ProShield

2031 700 000

dark iron > see chapter: Special glazes

Version

Without overflow
Glossy, matt, special colour

Fittings information

Impact area approx. 110 – 150 mm from rear edge of basin.
For parameters, see page 20.

Recommended miscellaneous

Bottle trap, Sl.2
Bottle trap, Sl.3
Drain valve, VT.1

Art. No.

8306 000 978
8312 000 978
8302 000 978

Undermount basins – K-series

Cut-out dimensions: Download www.alape.com

UB . K450



Undermount basin, round, Ø 409 mm, height 159 mm, glazed steel, without tap hole, with overflow, included fixing set, overflow set

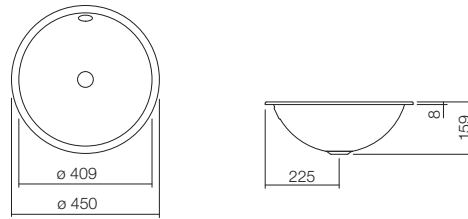

	Art. No.
white, ProShield	2032 700 000

Version
Without overflow
Glossy, matt, special colour

Fittings information

Impact area approx. 110 – 170 mm from rear edge of basin.
For parameters, see page 20.

Recommended miscellaneous	Art. No.
Bottle trap, SI.2	8306 000 978
Bottle trap, SI.3	8312 000 978
Drain valve, VT.1	8302 000 978

Undermount basins – KE-series (Unisono)Cut-out dimensions: Download www.alape.com**UB . KE325**

Undermount basin, round, Ø 319 mm, height 104 mm, glazed steel, without tap hole, without overflow, included fixing set, drain valve, valve cap, chrome-plated, Ø 63 mm

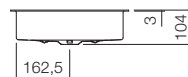
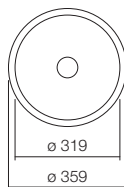
**Art. No.**

white, ProShield

3223 501 000

Version

Glossy, matt, special colour

Fittings information

Impact area approx. 102 – 137 mm from rear edge of basin.
For parameters, see page 20.

Recommended miscellaneous

Bottle trap, Sl.2
Bottle trap, Sl.3

Art. No.

8306 000 978
8312 000 978

UB . KE325

Undermount basin, round, Ø 319 mm, height 104 mm, glazed steel, without tap hole, without overflow, included fixing set, drain valve, valve cap, chrome-plated, Ø 63 mm, optimised for installation directly under the laminate layer of a coated counter top

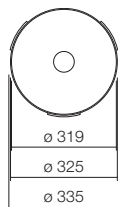
**Art. No.**

white, ProShield

3223 504 000

Version

Glossy, matt, special colour

Fittings information

Impact area approx. 102 – 137 mm from rear edge of basin.
For parameters, see page 20.

Recommended miscellaneous

Bottle trap, Sl.2
Bottle trap, Sl.3

Art. No.

8306 000 978
8312 000 978

Undermount basins – KE-series (Unisono)

Cut-out dimensions: Download www.alape.com

UB . KE375



Undermount basin, round, Ø 369 mm, height 114 mm, glazed steel, without tap hole, without overflow, included fixing set, drain valve, valve cap, chrome-plated, Ø 74 mm

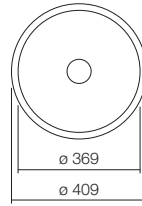

	Art. No.
white, ProShield	3224 501 000

Version	
Glossy, matt, special colour	

Fittings information

Impact area approx. 117 – 162 mm from rear edge of basin.
For parameters, see page 20.

Recommended miscellaneous

Bottle trap, Sl.2
Bottle trap, Sl.3

Art. No.

8306 000 978
8312 000 978

UB . KE375



Undermount basin, round, Ø 369 mm, height 114 mm, glazed steel, without tap hole, without overflow, included fixing set, drain valve, valve cap, chrome-plated, Ø 74 mm, optimised for installation directly under the laminate layer of a coated counter top

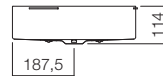
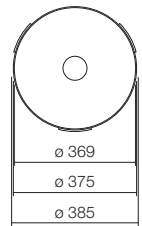

	Art. No.
white, ProShield	3224 504 000

Version	
Glossy, matt, special colour	

Fittings information

Impact area approx. 117 – 162 mm from rear edge of basin.
For parameters, see page 20.

Recommended miscellaneous

Bottle trap, Sl.2
Bottle trap, Sl.3

Art. No.

8306 000 978
8312 000 978

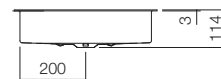
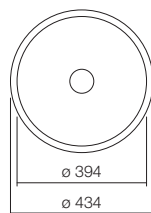
Undermount basins – KE-series (Unisono)Cut-out dimensions: Download www.alape.com**UB . KE400**

Undermount basin, round, Ø 394 mm, height 114 mm, glazed steel, without tap hole, without overflow, included fixing set, drain valve, valve cap, chrome-plated, Ø 74 mm

**Art. No.**

white, ProShield

3225 501 000

Version

Glossy, matt, special colour

Fittings information

Impact area approx. 122 – 167 mm from rear edge of basin.
For parameters, see page 20.

Recommended miscellaneous

Bottle trap, Sl.2
Bottle trap, Sl.3

Art. No.

8306 000 978
8312 000 978

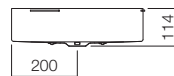
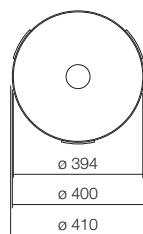
UB . KE400

Undermount basin, round, Ø 394 mm, height 114 mm, glazed steel, without tap hole, without overflow, included fixing set, drain valve, valve cap, chrome-plated, Ø 74 mm, optimised for installation directly under the laminate layer of a coated counter top

**Art. No.**

white, ProShield

3225 504 000

Version

Glossy, matt, special colour

Fittings information

Impact area approx. 122 – 167 mm from rear edge of basin.
For parameters, see page 20.

Recommended miscellaneous

Bottle trap, Sl.2
Bottle trap, Sl.3

Art. No.

8306 000 978
8312 000 978

Undermount basins – SO-series (Sondo)

Cut-out dimensions: Download www.alape.com

UB . S0450 . 1



Undermount basin, round, Ø 456 mm, height 115 mm, glazed steel, without tap hole, without overflow, included fixing set, drain valve, valve cap, chrome-plated, Ø 74 mm

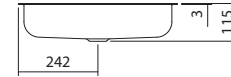
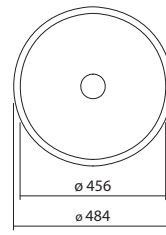

	Art. No.
white, ProShield	3505 501 000

Version	
Glossy, matt, special colour	

Fittings information

Impact area approx. 77 – 187 mm from rear edge of basin.
For parameters, see page 20.

Recommended miscellaneous

Bottle trap, Sl.2
Bottle trap, Sl.3

Art. No.

8306 000 978
8312 000 978

UB . S0450 . 1



Undermount basin, round, Ø 444 mm, height 115 mm, glazed steel, without tap hole, without overflow, included fixing set, drain valve, valve cap, chrome-plated, Ø 74 mm, optimised for installation directly under the laminate layer of a coated counter top

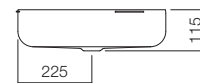
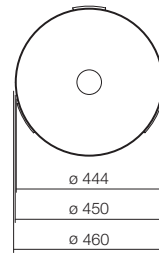

	Art. No.
white, ProShield	3505 504 000

Version	
Glossy, matt, special colour	

Fittings information

Impact area approx. 77 – 187 mm from rear edge of basin.
For parameters, see page 20.

Recommended miscellaneous

Bottle trap, Sl.2
Bottle trap, Sl.3

Art. No.

8306 000 978
8312 000 978

Undermount basins – SO-series (Sondo)Cut-out dimensions: Download www.alape.com**UB . S0450 . 2**

Undermount basin, round, Ø 456 mm, height 145 mm, glazed steel, without tap hole, without overflow, included fixing set, drain valve, valve cap, chrome-plated, Ø 74 mm

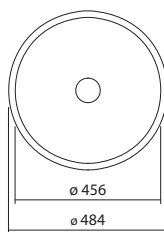
**Art. No.**

white, ProShield

3506 501 000

Version

Glossy, matt, special colour

Fittings information

Impact area approx. 77 – 187 mm from rear edge of basin.
For parameters, see page 20.

Recommended miscellaneous

Bottle trap, Sl.2
Bottle trap, Sl.3

Art. No.

8306 000 978
8312 000 978

UB . S0450 . 2

Undermount basin, round, Ø 444 mm, height 145 mm, glazed steel, without tap hole, without overflow, included fixing set, drain valve, valve cap, chrome-plated, Ø 74 mm, optimised for installation directly under the laminate layer of a coated counter top

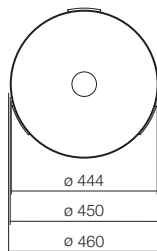
**Art. No.**

white, ProShield

3506 504 000

Version

Glossy, matt, special colour

Fittings information

Impact area approx. 77 – 187 mm from rear edge of basin.
For parameters, see page 20.

Recommended miscellaneous

Bottle trap, Sl.2
Bottle trap, Sl.3

Art. No.

8306 000 978
8312 000 978

Undermount basins – O-series

Cut-out dimensions: Download www.alape.com

UB . 0425

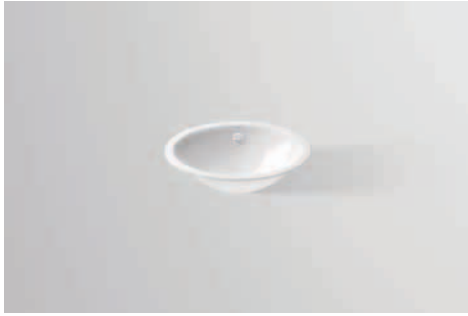

Undermount basin, oval, w/h/d 372/110/273 mm, glazed steel, without tap hole, with overflow, included fixing set, overflow set

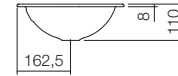
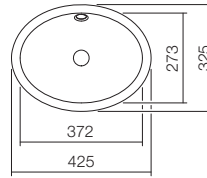

Art. No.

white, ProShield

2110 700 000

Version

Without overflow
Glossy, matt, special colour

Fittings information

Impact area approx. 100 – 125 mm from rear edge of basin.
For parameters, see page 20.

Recommended miscellaneous

Bottle trap, Sl.2
Bottle trap, Sl.3
Drain valve, VT.1

Art. No.

8306 000 978
8312 000 978
8302 000 978

UB . 0525



Undermount basin, oval, w/h/d 481/150/383 mm, glazed steel, without tap hole, with overflow, included fixing set, overflow set

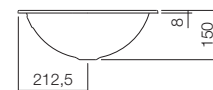
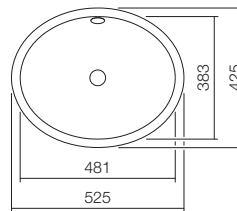

Art. No.

white, ProShield
dark iron > see chapter: Special glazes

2111 700 000

Version

Without overflow
Glossy, matt, special colour

Fittings information

Impact area approx. 120 – 165 mm from rear edge of basin.
For parameters, see page 20.

Recommended miscellaneous

Bottle trap, Sl.2
Bottle trap, Sl.3
Drain valve, VT.1

Art. No.

8306 000 978
8312 000 978
8302 000 978

Undermount basins – ME-series (Metaphor)Cut-out dimensions: Download www.alape.com**UB . ME500**

Undermount basin, rectangular, w/h/d 504/111/379 mm, glazed steel, without tap hole, with overflow, included fixing set, overflow set

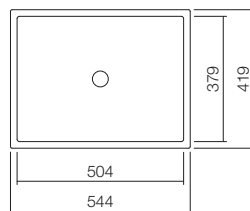
**Art. No.**

white, ProShield

3226 701 000

Version

Without overflow
Glossy, matt, special colour

Fittings information

Impact area approx. 112 – 157 mm from rear edge of basin.
For parameters, see page 20.

Recommended miscellaneous

Bottle trap, Sl.2
Bottle trap, Sl.3
Drain valve, VT.1

Art. No.

8306 000 978
8312 000 978
8302 000 978

UB . ME500

Undermount basin, rectangular, w/h/d 494/111/369 mm, glazed steel, without tap hole, with overflow, included fixing set, overflow set, optimised for installation directly under the laminate layer of a coated counter top

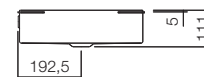
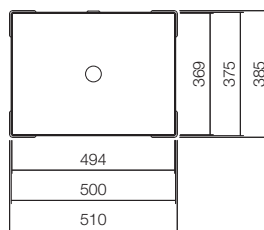
**Art. No.**

white, ProShield

3226 704 000

Version

Without overflow
Glossy, matt, special colour

Fittings information

Impact area approx. 112 – 157 mm from rear edge of basin.
For parameters, see page 20.

Recommended miscellaneous

Bottle trap, Sl.2
Bottle trap, Sl.3
Drain valve, VT.1

Art. No.

8306 000 978
8312 000 978
8302 000 978

Undermount basins – ME-series (Metaphor)

Cut-out dimensions: Download www.alape.com

UB . ME750



Undermount basin, rectangular, w/h/d 754/111/379 mm, glazed steel, without tap hole, with overflow, included fixing set, overflow set

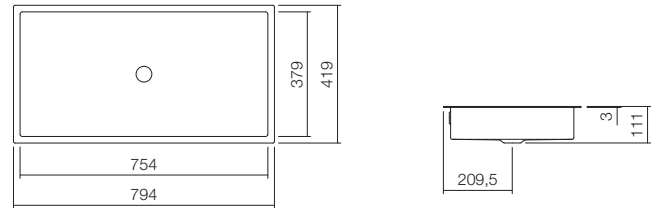

	Art. No.
white, ProShield	3227 701 000

Version
Without overflow
Glossy, matt, special colour

Fittings information

Impact area approx. 112 – 157 mm from rear edge of basin.
For parameters, see page 20.

Recommended miscellaneous	Art. No.
Bottle trap, Sl.2	8306 000 978
Bottle trap, Sl.3	8312 000 978
Drain valve, VT.1	8302 000 978

UB . ME750



Undermount basin, rectangular, w/h/d 744/111/369 mm, glazed steel, without tap hole, with overflow, included fixing set, overflow set, optimised for installation directly under the laminate layer of a coated counter top

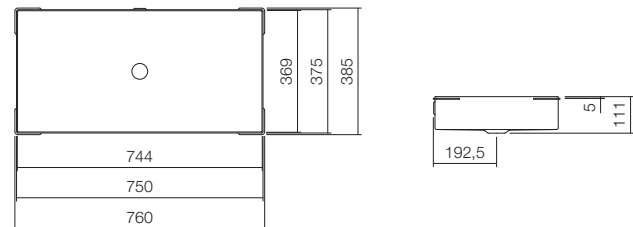

	Art. No.
white, ProShield	3227 704 000

Version
Without overflow
Glossy, matt, special colour

Fittings information

Impact area approx. 112 – 157 mm from rear edge of basin.
For parameters, see page 20.

Recommended miscellaneous	Art. No.
Bottle trap, Sl.2	8306 000 978
Bottle trap, Sl.3	8312 000 978
Drain valve, VT.1	8302 000 978

Undermount basins – ME-series (Metaphor)Cut-out dimensions: Download www.alape.com**UB . ME1000**

Undermount basin, rectangular, w/h/d 1004/111/379 mm, glazed steel, without tap hole, with overflow, included fixing set, overflow set

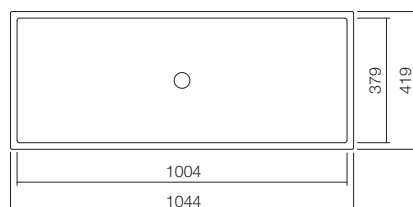
**Art. No.**

white, ProShield

3228 701 000

Version

Without overflow
Glossy, matt, special colour

Fittings information

Impact area approx. 112 – 157 mm from rear edge of basin.
For parameters, see page 20.

Recommended miscellaneous

Bottle trap, Sl.2
Bottle trap, Sl.3
Drain valve, VT.1

Art. No.

8306 000 978
8312 000 978
8302 000 978

UB . ME1000

Undermount basin, rectangular, w/h/d 994/111/369 mm, glazed steel, without tap hole, with overflow, included fixing set, overflow set, optimised for installation directly under the laminate layer of a coated counter top

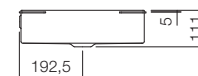
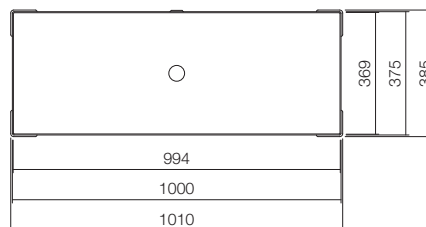
**Art. No.**

white, ProShield

3228 704 000

Version

Without overflow
Glossy, matt, special colour

Fittings information

Impact area approx. 112 – 157 mm from rear edge of basin.
For parameters, see page 20.

Recommended miscellaneous

Bottle trap, Sl.2
Bottle trap, Sl.3
Drain valve, VT.1

Art. No.

8306 000 978
8312 000 978
8302 000 978

Undermount basins – SR-series, R-series

Cut-out dimensions: Download www.alape.com

UB . SR650



Undermount basin, rectangular, w/h/d 609/127/359 mm, glazed steel, without tap hole, with overflow, included fixing set, overflow set

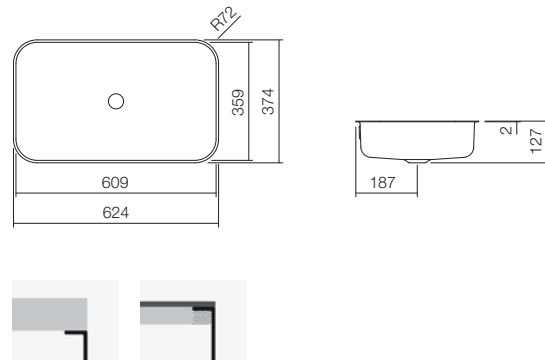

	Art. No.
white, ProShield	2255 700 000

Version
Without overflow
Glossy, matt, special colour

Fittings information

Impact area approx. 70 – 120 mm from rear edge of basin.
For parameters, see page 20.

Recommended miscellaneous	Art. No.
Bottle trap, Sl.2	8306 000 978
Bottle trap, Sl.3	8312 000 978
Drain valve, VT.1	8302 000 978

UB . R585



Undermount basin, rectangular, w/h/d 507/143/273 mm, glazed steel, without tap hole, with overflow, included fixing set, overflow set

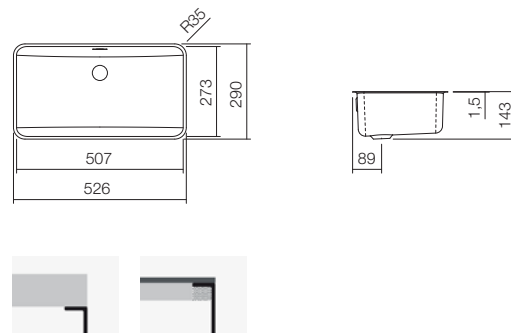

	Art. No.
white, ProShield	2250 700 000

Version
Without overflow
Glossy, matt, special colour

Fittings information

Impact area approx. 133 – 153 mm from rear edge of basin.
For parameters, see page 20.

Recommended miscellaneous	Art. No.
Bottle trap, Sl.2	8306 000 978
Bottle trap, Sl.3	8312 000 978
Drain valve, VT.1	8302 000 978

Undermount basins – R-series, RE-seriesCut-out dimensions: Download www.alape.com**UB . R800**

Undermount basin, rectangular, w/h/d 703/120/360 mm, glazed steel, without tap hole, with overflow, included fixing set, overflow set

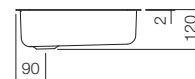
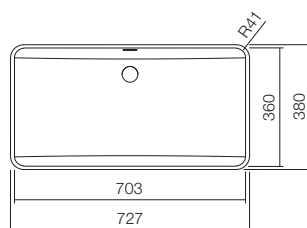
**Art. No.**

white, ProShield

2251 700 000

Version

Without overflow
Glossy, matt, special colour

Fittings information

Impact area approx. 145.5 – 200.5 mm from rear edge of basin.
For parameters, see page 20.

Recommended miscellaneous

Bottle trap, Sl.2
Bottle trap, Sl.3
Drain valve, VT.1

Art. No.

8306 000 978
8312 000 978
8302 000 978

UB . RE700 . 4

Undermount basin, rectangular, w/h/d 645/90/343 mm, glazed steel, without tap hole, without overflow, included fixing set, drain valve, valve cap, white glazed, w/d 68/68 mm

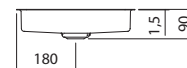
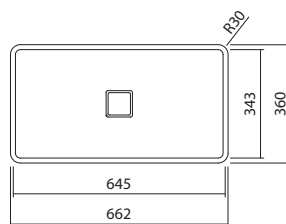
**Art. No.**

white, ProShield

2258 500 000

Version

Glossy, matt, special colour

Fittings information

Impact area approx. 86 – 121 mm from rear edge of basin.
For parameters, see page 20.

Recommended miscellaneous

Bottle trap, Sl.2
Bottle trap, Sl.3

Art. No.

8306 000 978
8312 000 978

Undermount basins – Q-series

Cut-out dimensions: Download www.alape.com

UB . Q450



Undermount basin, square, w/h/d 371/94/371 mm, glazed steel, without tap hole, without overflow, included fixing set, drain valve, valve cap, white glazed, w/d 68/68 mm

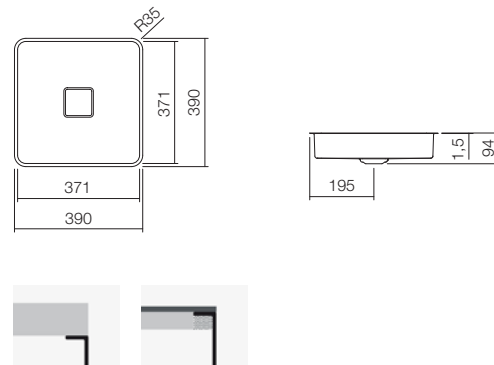

Art. No.

white, ProShield

2312 500 000

Version

Glossy, matt, special colour

Fittings information

Impact area approx. 85 – 140 mm from rear edge of basin.
For parameters, see page 20.

Recommended miscellaneous

Bottle trap, Sl.2
Bottle trap, Sl.3

Art. No.























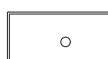

8306 000 978
8312 000 978

Built-in basins

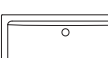
EB

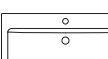

Built-in basin
EB.R800 H
800 x 120 x 500 mm

Basin width				
325 – 425mm	450 – 600mm	600 – 700mm	750 – 800mm	
 EB.K325 ø 325mm I P. 43	 EB.K450 ø 450mm I P. 47			Round
 EB.K400 ø 400mm I P. 45	 EB.K450H ø 450mm I P. 46			
 EB.K400H ø 400mm I P. 44	 EB.S450H ø 450mm I P. 42			
 EB.KE375 ø 375mm I P. 48	 HB.S450H ø 450mm I P. 62			
 EB.KE400 ø 400mm I P. 48	 EW 3/EW 3.2 ø 475mm I P. 40/41			
 EB.0425 425 x 325mm I P. 49	 EB.0525 525 x 425mm I P. 51			Oval
	 EB.0500H 500 x 400mm I P. 50	 EB.0600H 600 x 500mm I P. 52		
	 EB.Q450 450 x 450mm I P. 61	 EB.SR650 650 x 415mm I P. 55	 EB.ME750 750 x 375mm I P. 53	Square and rectangular
	 EB.Q450H 450 x 500mm I P. 61	 EB.SR650H 650 x 472mm I P. 54	 EB.R800 800 x 450mm I P. 59	
	 EB.ME500 500 x 375mm I P. 53	 EB.RE700H.2 700 x 460mm I P. 60	 EB.R800H 800 x 500mm I P. 58	
	 EB.R585 585 x 347mm I P. 57	 EB.RE700.4 700 x 398mm I P. 60		
	 EB.R585H 585 x 405mm I P. 56			
	 HB.R585H 585 x 405mm I P. 62			

Built-in basins – EW-seriesCut-out dimensions: Download www.alape.com**EW 3**

Built-in basin, round, Ø 475 mm, height 186 mm, glazed steel, with one tap hole, with overflow, included fixing set, overflow set, PVC seal

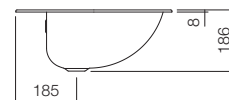
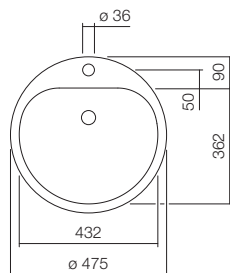
**Art. No.**

white, ProShield

2005 000 000

Version

Without tap hole
3 Drill holes
Drill hole for lotion dispenser
Glossy, matt, special colour

Fittings information

Impact area approx. 190 – 270 mm from middle of tap hole.
For parameters, see page 20.

Recommended miscellaneous

Bottle trap, Sl.2
Bottle trap, Sl.3
Drain valve, VT.1
Angle valve cover, EV.3

Art. No.

8306 000 978
8312 000 978
8302 000 978
8110 000 978

EW 3

Built-in basin, round, Ø 475 mm, height 186 mm, glazed steel, with one tap hole, without overflow, included fixing set, PVC seal

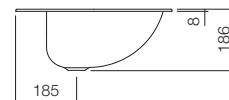
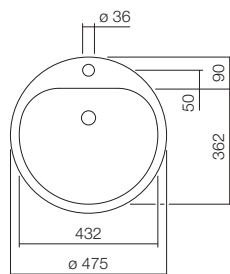
**Art. No.**

white, ProShield

2005 100 000

Version

Without tap hole
3 Drill holes
Drill hole for lotion dispenser
Glossy, matt, special colour

Fittings information

Impact area approx. 190 – 270 mm from middle of tap hole.
For parameters, see page 20.

Recommended miscellaneous

Bottle trap, Sl.2
Bottle trap, Sl.3
Drain valve, VT.3
Angle valve cover, EV.3

Art. No.

8306 000 978
8312 000 978
8305 000 000
8110 000 978

Built-in basins – EW-series

Cut-out dimensions: Download www.alape.com

EW 3.2



Built-in basin, round, Ø 475 mm, height 186 mm, glazed steel, with one tap hole, with overflow, included fixing set, overflow set

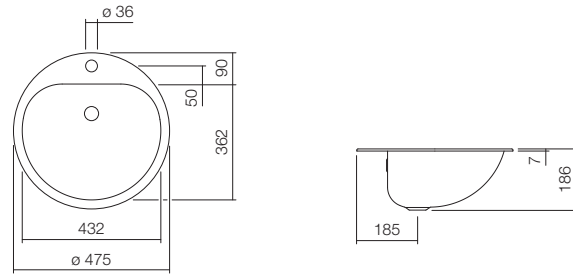

	Art. No.
white, ProShield	2018 000 000

Version
Without tap hole
3 Drill holes
Drill hole for lotion dispenser
Glossy, matt, special colour

Fittings information

Impact area approx. 190 – 270 mm from middle of tap hole.
For parameters, see page 20.

Recommended miscellaneous	Art. No.
Bottle trap, Sl.2	8306 000 978
Bottle trap, Sl.3	8312 000 978
Drain valve, VT.1	8302 000 978
Angle valve cover, EV.3	8110 000 978

EW 3.2



Built-in basin, round, Ø 475 mm, height 186 mm, glazed steel, with one tap hole, without overflow, included fixing set

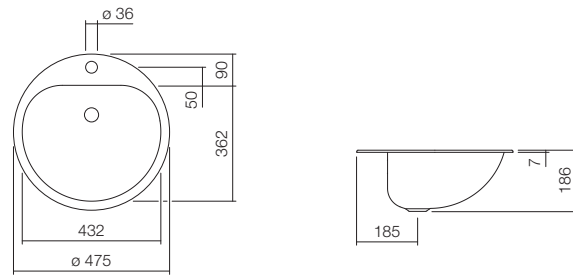

	Art. No.
white, ProShield	2018 100 000

Version
Without tap hole
3 Drill holes
Drill hole for lotion dispenser
Glossy, matt, special colour

Fittings information

Impact area approx. 190 – 270 mm from middle of tap hole.
For parameters, see page 20.

Recommended miscellaneous	Art. No.
Bottle trap, Sl.2	8306 000 978
Bottle trap, Sl.3	8312 000 978
Drain valve, VT.3	8305 000 000
Angle valve cover, EV.3	8110 000 978

Built-in basins – S-seriesCut-out dimensions: Download www.alape.com**EB . S450H**

Built-in basin, round, Ø 450 mm, height 163 mm, glazed steel, with one tap hole, with overflow, included fixing set, overflow set

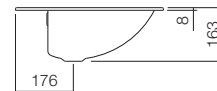
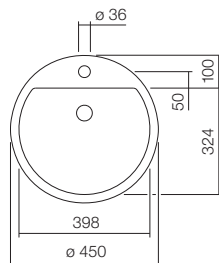

	Art. No.
white, ProShield	2406 000 000

Version
Without tap hole
3 Drill holes
Drill hole for lotion dispenser
Glossy, matt, special colour

Fittings information
Impact area approx. 170 – 210 mm from middle of tap hole.
For parameters, see page 20.

Recommended miscellaneous	Art. No.
Bottle trap, Sl.2	8306 000 978
Bottle trap, Sl.3	8312 000 978
Drain valve, VT.1	8302 000 978
Angle valve cover, EV.3	8110 000 978

EB . S450H

Built-in basin, round, Ø 450 mm, height 163 mm, glazed steel, with one tap hole, without overflow, included fixing set

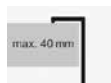
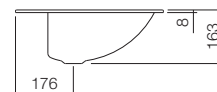
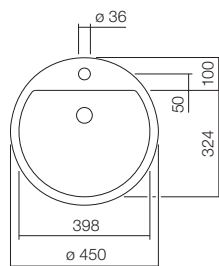

	Art. No.
white, ProShield	2406 100 000

Version
Without tap hole
3 Drill holes
Drill hole for lotion dispenser
Glossy, matt, special colour

Fittings information
Impact area approx. 170 – 210 mm from middle of tap hole.
For parameters, see page 20.

Recommended miscellaneous	Art. No.
Bottle trap, Sl.2	8306 000 978
Bottle trap, Sl.3	8312 000 978
Drain valve, VT.3	8305 000 000
Angle valve cover, EV.3	8110 000 978

Built-in basins – K-series

Cut-out dimensions: Download www.alape.com

EB . K325



Built-in basin, round, Ø 325 mm, height 110 mm, glazed steel, without tap hole, with overflow, included fixing set, overflow set

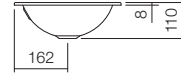
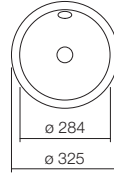

Art. No.

white, ProShield

2000 200 000

Version

Glossy, matt, special colour

Fittings information

Impact area approx. 85 – 115 mm from rear edge of basin.
For parameters, see page 20.

Recommended miscellaneous

Bottle trap, Sl.2
Bottle trap, Sl.3
Drain valve, VT.1
Angle valve cover, EV.3

Art. No.

8306 000 978
8312 000 978
8302 000 978
8110 000 978

EB . K325



Built-in basin, round, Ø 325 mm, height 110 mm, glazed steel, without tap hole, without overflow, included fixing set

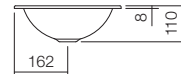
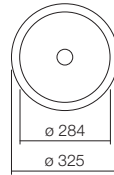

Art. No.

white, ProShield

2000 000 000

Version

Glossy, matt, special colour

Fittings information

Impact area approx. 85 – 115 mm from rear edge of basin.
For parameters, see page 20.

Recommended miscellaneous

Bottle trap, Sl.2
Bottle trap, Sl.3
Drain valve, VT.2
Angle valve cover, EV.3

Art. No.

8306 000 978
8312 000 978
8304 000 000
8110 000 978

Built-in basins – K-seriesCut-out dimensions: Download www.alape.com**EB . K400H**

Built-in basin, round, Ø 400 mm, height 110 mm, glazed steel, with one tap hole, with overflow, included fixing set, overflow set

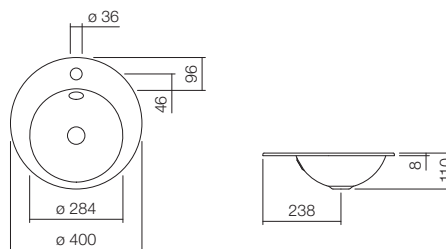

	Art. No.
white, ProShield	2003 200 000

Version
Without tap hole
3 Drill holes
Drill hole for lotion dispenser
Glossy, matt, special colour

Fittings information
Impact area approx. 110 – 140 mm from middle of tap hole.
For parameters, see page 20.

Recommended miscellaneous	Art. No.
Bottle trap, Sl.2	8306 000 978
Bottle trap, Sl.3	8312 000 978
Drain valve, VT.1	8302 000 978
Angle valve cover, EV.3	8110 000 978

EB . K400H

Built-in basin, round, Ø 400 mm, height 110 mm, glazed steel, with one tap hole, without overflow, included fixing set

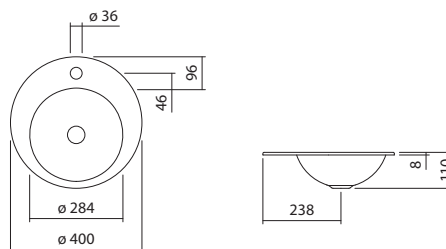

	Art. No.
white, ProShield	2003 000 000

Version
Without tap hole
3 Drill holes
Drill hole for lotion dispenser
Glossy, matt, special colour

Fittings information
Impact area approx. 110 – 140 mm from middle of tap hole.
For parameters, see page 20.

Recommended miscellaneous	Art. No.
Bottle trap, Sl.2	8306 000 978
Bottle trap, Sl.3	8312 000 978
Drain valve, VT.2	8304 000 000
Angle valve cover, EV.3	8110 000 978

Built-in basins – K-seriesCut-out dimensions: Download www.alape.com**EB . K400**

Built-in basin, round, Ø 400 mm, height 140 mm, glazed steel, without tap hole, with overflow, included fixing set, overflow set

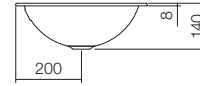
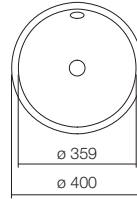
**Art. No.**

white, ProShield

2001 000 000

Version

Glossy, matt, special colour

Fittings information

Impact area approx. 110 – 150 mm from rear edge of basin.
For parameters, see page 20.

Recommended miscellaneous**Art. No.**

Bottle trap, Sl.2	8306 000 978
Bottle trap, Sl.3	8312 000 978
Drain valve, VT.1	8302 000 978
Angle valve cover, EV.3	8110 000 978

EB . K400

Built-in basin, round, Ø 400 mm, height 140 mm, glazed steel, without tap hole, without overflow, included fixing set

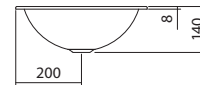
**Art. No.**

white, ProShield

2001 100 000

Version

Glossy, matt, special colour

Fittings information

Impact area approx. 110 – 150 mm from rear edge of basin.
For parameters, see page 20.

Recommended miscellaneous**Art. No.**

Bottle trap, Sl.2	8306 000 978
Bottle trap, Sl.3	8312 000 978
Drain valve, VT.3	8305 000 000
Angle valve cover, EV.3	8110 000 978

Built-in basins – K-seriesCut-out dimensions: Download www.alape.com**EB . K450H**

Built-in basin, round, Ø 450 mm, height 129 mm, glazed steel, with one tap hole, with overflow, included fixing set, overflow set

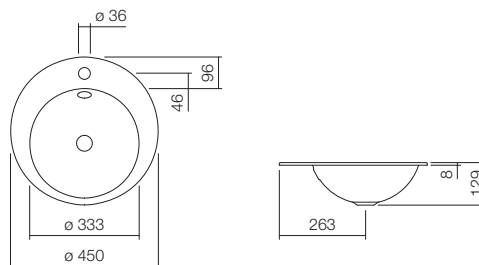

	Art. No.
white, ProShield	2004 000 000

Version
Without tap hole
3 Drill holes
Drill hole for lotion dispenser
Glossy, matt, special colour

Fittings information

Impact area approx. 140 – 160 mm from middle of tap hole.
For parameters, see page 20.

Recommended miscellaneous	Art. No.
Bottle trap, Sl.2	8306 000 978
Bottle trap, Sl.3	8312 000 978
Drain valve, VT.1	8302 000 978
Angle valve cover, EV.3	8110 000 978

EB . K450H

Built-in basin, round, Ø 450 mm, height 129 mm, glazed steel, with one tap hole, without overflow, included fixing set

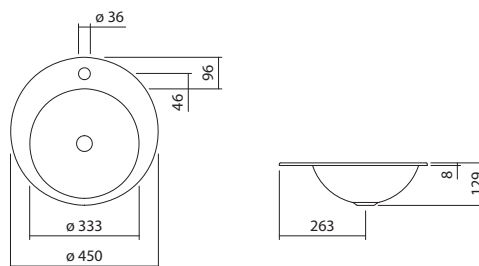

	Art. No.
white, ProShield	2004 100 000

Version
Without tap hole
3 Drill holes
Drill hole for lotion dispenser
Glossy, matt, special colour

Fittings information

Impact area approx. 140 – 160 mm from middle of tap hole.
For parameters, see page 20.

Recommended miscellaneous	Art. No.
Bottle trap, Sl.2	8306 000 978
Bottle trap, Sl.3	8312 000 978
Drain valve, VT.3	8305 000 000
Angle valve cover, EV.3	8110 000 978

Built-in basins – K-series

Cut-out dimensions: Download www.alape.com

EB . K450



Built-in basin, round, Ø 450 mm, height 159 mm, glazed steel, without tap hole, with overflow, included fixing set, overflow set

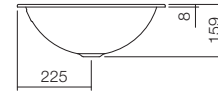
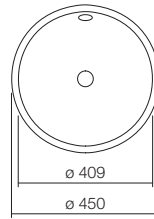

Art. No.
white, ProShield
2002 000 000

Version
Glossy, matt, special colour

Fittings information

Impact area approx. 110 – 170 mm from rear edge of basin.
For parameters, see page 20.

Recommended miscellaneous

Art. No.
Bottle trap, Sl.2
8306 000 978
Bottle trap, Sl.3
8312 000 978
Drain valve, VT.1
8302 000 978
Angle valve cover, EV.3
8110 000 978

EB . K450



Built-in basin, round, Ø 450 mm, height 159 mm, glazed steel, without tap hole, without overflow, included fixing set

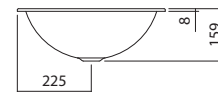
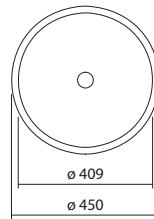

Art. No.
white, ProShield
2002 100 000

Version
Glossy, matt, special colour

Fittings information

Impact area approx. 110 – 170 mm from rear edge of basin.
For parameters, see page 20.

Recommended miscellaneous

Art. No.
Bottle trap, Sl.2
8306 000 978
Bottle trap, Sl.3
8312 000 978
Drain valve, VT.3
8305 000 000
Angle valve cover, EV.3
8110 000 978

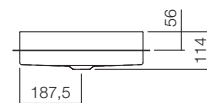
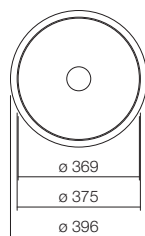
Built-in basins – KE-series (Unisono)Cut-out dimensions: Download www.alape.com**EB . KE375**

Built-in basin for 30mm thick counter tops, round, Ø 375 mm, height 114 mm, extending 25 mm over counter top, glazed steel, without tap hole, without overflow, included fixing set, drain valve, valve cap, chrome-plated, Ø 74 mm



	Art. No.
white, ProShield	2024 503 000

Version	
Glossy, matt, special colour	

Fittings information

Impact area approx. 110 – 155 mm from rear edge of basin.
For parameters, see page 20.

Recommended miscellaneous

Bottle trap, Sl.2
Bottle trap, Sl.3

Art. No.

8306 000 978
8312 000 978

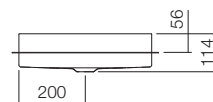
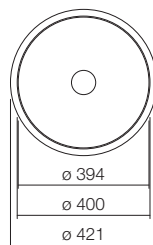
EB . KE400

Built-in basin for 30mm thick counter tops, round, Ø 400 mm, height 114 mm, extending 25 mm over counter top, glazed steel, without tap hole, without overflow, included fixing set, drain valve, valve cap, chrome-plated, Ø 74 mm



	Art. No.
white, ProShield	2025 503 000

Version	
Glossy, matt, special colour	

Fittings information

Impact area approx. 115 – 160 mm from rear edge of basin.
For parameters, see page 20.

Recommended miscellaneous

Bottle trap, Sl.2
Bottle trap, Sl.3

Art. No.

8306 000 978
8312 000 978

Built-in basins – O-seriesCut-out dimensions: Download www.alape.com**EB . 0425**

Built-in basin, oval, w/h/d 425/110/325 mm, glazed steel, without tap hole, with overflow, included fixing set, overflow set

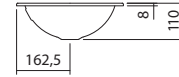
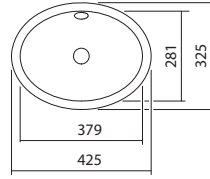

Art. No.
white, ProShield 2100 000 000

Version
Glossy, matt, special colour

Fittings information

Impact area approx. 100 – 125 mm from rear edge of basin.
For parameters, see page 20.

Recommended miscellaneous

Bottle trap, Sl.2
Bottle trap, Sl.3
Drain valve, VT.1

Art. No.

8306 000 978
8312 000 978
8302 000 978

EB . 0425

Built-in basin, oval, w/h/d 425/110/325 mm, glazed steel, without tap hole, without overflow, included fixing set

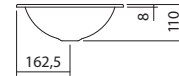
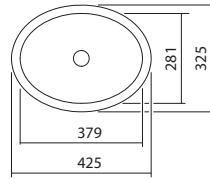

Art. No.
white, ProShield 2100 100 000

Version
Glossy, matt, special colour

Fittings information

Impact area approx. 100 – 125 mm from rear edge of basin.
For parameters, see page 20.

Recommended miscellaneous

Bottle trap, Sl.2
Bottle trap, Sl.3
Drain valve, VT.2

Art. No.

8306 000 978
8312 000 978
8304 000 000

Built-in basins – O-seriesCut-out dimensions: Download www.alape.com**EB . 0500H**

Built-in basin, oval, w/h/d 500/110.5/400 mm, glazed steel, with one tap hole, with overflow, included fixing set, overflow set

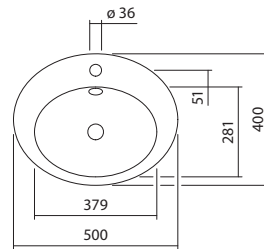
**Art. No.**

white, ProShield

2102 000 000

Version

Without tap hole
3 Drill holes
Drill hole for lotion dispenser
Glossy, matt, special colour

Fittings information

Impact area approx. 120 – 140 mm from middle of tap hole.
For parameters, see page 20.

Recommended miscellaneous

Bottle trap, Sl.2
Bottle trap, Sl.3
Drain valve, VT.1
Angle valve cover, EV.3

Art. No.

8306 000 978
8312 000 978
8302 000 978
8110 000 978

EB . 0500H

Built-in basin, oval, w/h/d 500/110.5/400 mm, glazed steel, with one tap hole, without overflow, included fixing set

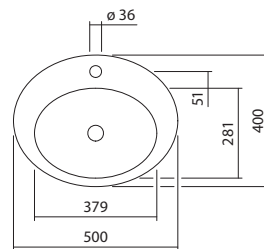
**Art. No.**

white, ProShield

2102 100 000

Version

Without tap hole
3 Drill holes
Drill hole for lotion dispenser
Glossy, matt, special colour

Fittings information

Impact area approx. 120 – 140 mm from middle of tap hole.
For parameters, see page 20.

Recommended miscellaneous

Bottle trap, Sl.2
Bottle trap, Sl.3
Drain valve, VT.2
Angle valve cover, EV.3

Art. No.

8306 000 978
8312 000 978
8304 000 000
8110 000 978

Built-in basins – O-seriesCut-out dimensions: Download www.alape.com**EB . 0525**

Built-in basin, oval, w/h/d 525/150/425 mm, glazed steel, without tap hole, with overflow, included fixing set, overflow set

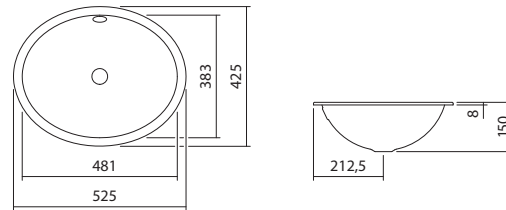

Art. No.
white, ProShield 2101 000 000

Version
Glossy, matt, special colour

Fittings information

Impact area approx. 120 – 165 mm from rear edge of basin.
For parameters, see page 20.

Recommended miscellaneous

Bottle trap, Sl.2
Bottle trap, Sl.3
Drain valve, VT.1

Art. No.

8306 000 978
8312 000 978
8302 000 978

EB . 0525

Built-in basin, oval, w/h/d 525/150/425 mm, glazed steel, without tap hole, without overflow, included fixing set

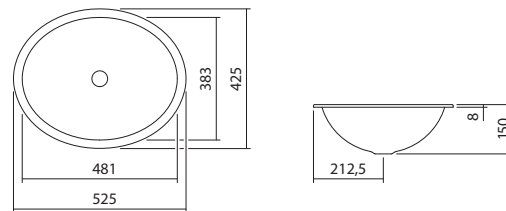

Art. No.
white, ProShield 2101 100 000

Version
Glossy, matt, special colour

Fittings information

Impact area approx. 120 – 165 mm from rear edge of basin.
For parameters, see page 20.

Recommended miscellaneous

Bottle trap, Sl.2
Bottle trap, Sl.3
Drain valve, VT.3

Art. No.

8306 000 978
8312 000 978
8305 000 000

Built-in basins – O-seriesCut-out dimensions: Download www.alape.com**EB . 0600H**

Built-in basin, oval, w/h/d 600/150/500 mm, glazed steel, with one tap hole, with overflow, included fixing set, overflow set

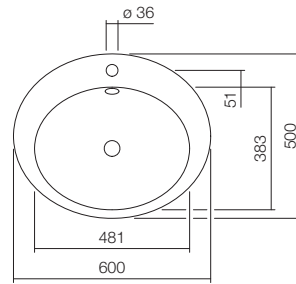
**Art. No.**

white, ProShield

2104 000 000

Version

Without tap hole
3 Drill holes
Drill hole for lotion dispenser
Glossy, matt, special colour

Fittings information

Impact area approx. 160 – 180 mm from middle of tap hole.
For parameters, see page 20.

Recommended miscellaneous

Bottle trap, Sl.2
Bottle trap, Sl.3
Drain valve, VT.1
Angle valve cover, EV.3

Art. No.

8306 000 978
8312 000 978
8302 000 978
8110 000 978

EB . 0600H

Built-in basin, oval, w/h/d 600/150/500 mm, glazed steel, with one tap hole, without overflow, included fixing set

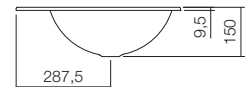
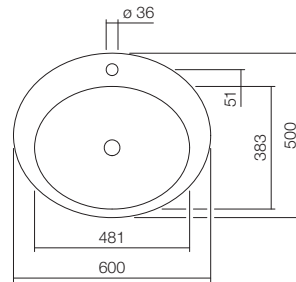
**Art. No.**

white, ProShield

2104 100 000

Version

Without tap hole
3 Drill holes
Drill hole for lotion dispenser
Glossy, matt, special colour

Fittings information

Impact area approx. 160 – 180 mm from middle of tap hole.
For parameters, see page 20.

Recommended miscellaneous

Bottle trap, Sl.2
Bottle trap, Sl.3
Drain valve, VT.3
Angle valve cover, EV.3

Art. No.

8306 000 978
8312 000 978
8305 000 000
8110 000 978

Built-in basins – ME-series (Metaphor)Cut-out dimensions: Download www.alape.com**EB . ME500**

Built-in basin for 30mm thick counter tops, rectangular, w/h/d 500/111/375 mm, extending 25 mm over counter top, glazed steel, without tap hole, without overflow, included fixing set, drain valve, valve cap, chrome-plated, Ø 63 mm

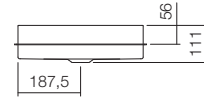
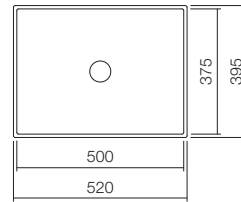

	Art. No.
white, ProShield	2226 503 000

Version	
Glossy, matt, special colour	

Fittings information

Impact area approx. 100 – 145 mm from rear edge of basin.
For parameters, see page 20.

Recommended miscellaneous

Bottle trap, Sl.2
Bottle trap, Sl.3

Art. No.

8306 000 978
8312 000 978

EB . ME750

Built-in basin for 30mm thick counter tops, rectangular, w/h/d 750/111/375 mm, extending 25 mm over counter top, glazed steel, without tap hole, without overflow, included fixing set, drain valve, valve cap, chrome-plated, Ø 63 mm

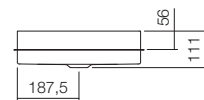
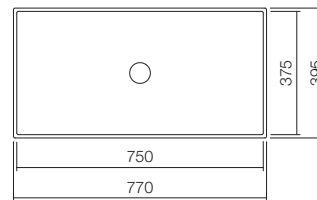

	Art. No.
white, ProShield	2227 503 000

Version	
Glossy, matt, special colour	

Fittings information

Impact area approx. 100 – 145 mm from rear edge of basin.
For parameters, see page 20.

Recommended miscellaneous

Bottle trap, Sl.2
Bottle trap, Sl.3

Art. No.

8306 000 978
8312 000 978

Built-in basins – SR-series (Stream)Cut-out dimensions: Download www.alape.com**EB . SR650H**

Built-in basin, rectangular, w/h/d 650/127/472 mm, glazed steel, with one tap hole, with overflow, included fixing set, overflow set

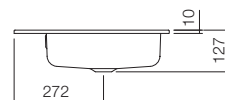
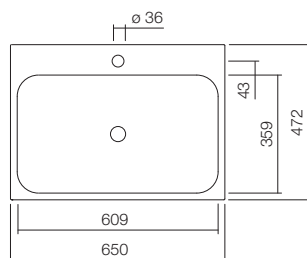

	Art. No.
white, ProShield	2219 600 000

Fittings information

Impact area approx. 105 – 155 mm from middle of tap hole.
For parameters, see page 20.

Version
Without tap hole
3 Drill holes
Drill hole for lotion dispenser
Glossy, matt, special colour

Recommended miscellaneous	Art. No.
Bottle trap, Sl.2	8306 000 978
Bottle trap, Sl.3	8312 000 978
Drain valve, VT.1	8302 000 978
Angle valve cover, EV.3	8110 000 978

EB . SR650H

Built-in basin, rectangular, w/h/d 650/127/472 mm, glazed steel, with one tap hole, without overflow, included fixing set

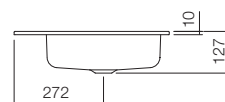
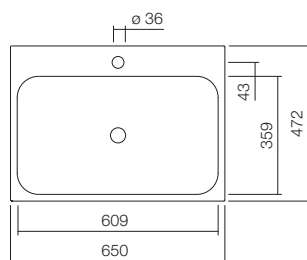

	Art. No.
white, ProShield	2219 800 000

Fittings information

Impact area approx. 105 – 155 mm from middle of tap hole.
For parameters, see page 20.

Version
Without tap hole
3 Drill holes
Drill hole for lotion dispenser
Glossy, matt, special colour

Recommended miscellaneous	Art. No.
Bottle trap, Sl.2	8306 000 978
Bottle trap, Sl.3	8312 000 978
Drain valve, VT.3	8305 000 000
Angle valve cover, EV.3	8110 000 978

Built-in basins – SR-series (Stream)Cut-out dimensions: Download www.alape.com**EB . SR650**

Built-in basin, rectangular, w/h/d 650/127/415 mm, glazed steel, without tap hole, with overflow, included fixing set, overflow set

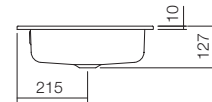
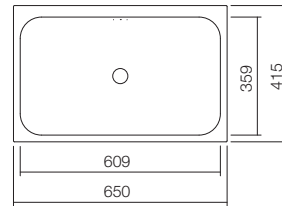

	Art. No.
white, ProShield	2218 700 000

Version	
Glossy, matt, special colour	

Fittings information

Impact area approx. 98 – 148 mm from rear edge of basin.
For parameters, see page 20.

Recommended miscellaneous

Bottle trap, Sl.2
Bottle trap, Sl.3
Drain valve, VT.1

Art. No.

8306 000 978
8312 000 978
8302 000 978

EB . SR650

Built-in basin, rectangular, w/h/d 650/127/415 mm, glazed steel, without tap hole, without overflow, included fixing set

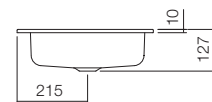
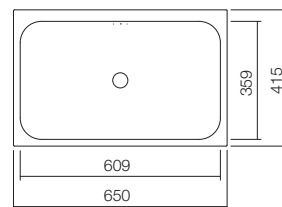

	Art. No.
white, ProShield	2218 500 000

Version	
Glossy, matt, special colour	

Fittings information

Impact area approx. 98 – 148 mm from rear edge of basin.
For parameters, see page 20.

Recommended miscellaneous

Bottle trap, Sl.2
Bottle trap, Sl.3
Drain valve, VT.3

Art. No.

8306 000 978
8312 000 978
8305 000 000

Built-in basins – R-seriesCut-out dimensions: Download www.alape.com**EB . R585H**

Built-in basin, rectangular, w/h/d 585/143/405 mm, glazed steel, with one tap hole, with overflow, included fixing set, overflow set

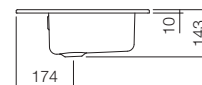
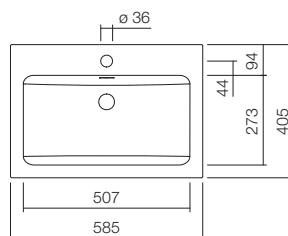

	Art. No.
white, ProShield	2202 000 000

Version
Without tap hole
3 Drill holes
Drill hole for lotion dispenser
Glossy, matt, special colour

Fittings information
Impact area approx. 170 – 190 mm from middle of tap hole.
For parameters, see page 20.

Recommended miscellaneous	Art. No.
Bottle trap, Sl.2	8306 000 978
Bottle trap, Sl.3	8312 000 978
Drain valve, VT.1	8302 000 978
Angle valve cover, EV.3	8110 000 978

EB . R585H

Built-in basin, rectangular, w/h/d 585/143/405 mm, glazed steel, with one tap hole, without overflow, included fixing set

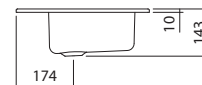
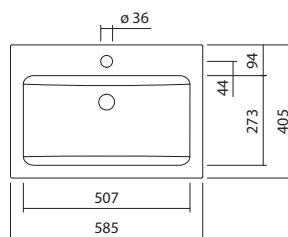

	Art. No.
white, ProShield	2202 100 000

Version
Without tap hole
3 Drill holes
Drill hole for lotion dispenser
Glossy, matt, special colour

Fittings information
Impact area approx. 170 – 190 mm from middle of tap hole.
For parameters, see page 20.

Recommended miscellaneous	Art. No.
Bottle trap, Sl.2	8306 000 978
Bottle trap, Sl.3	8312 000 978
Drain valve, VT.3	8305 000 000
Angle valve cover, EV.3	8110 000 978

Built-in basins – R-series

Cut-out dimensions: Download www.alape.com

EB . R585



Built-in basin, rectangular, w/h/d 585/143/347 mm, glazed steel, without tap hole, with overflow, included fixing set, overflow set

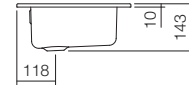
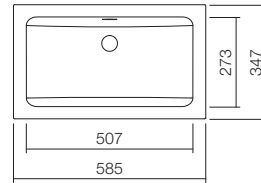

	Art. No.
white, ProShield	2201 000 000

	Version
	Glossy, matt, special colour

Fittings information

Impact area approx. 160 – 180 mm from rear edge of basin.
For parameters, see page 20.

Recommended miscellaneous

Bottle trap, Sl.2
Bottle trap, Sl.3
Drain valve, VT.1

Art. No.

8306 000 978
8312 000 978
8302 000 978

EB . R585



Built-in basin, rectangular, w/h/d 585/143/347 mm, glazed steel, without tap hole, without overflow, included fixing set

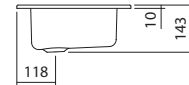
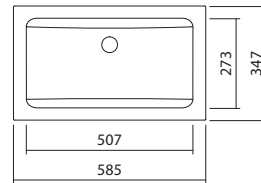

	Art. No.
white, ProShield	2201 100 000

	Version
	Glossy, matt, special colour

Fittings information

Impact area approx. 160 – 180 mm from rear edge of basin.
For parameters, see page 20.

Recommended miscellaneous

Bottle trap, Sl.2
Bottle trap, Sl.3
Drain valve, VT.3

Art. No.

8306 000 978
8312 000 978
8305 000 000

Built-in basins – R-seriesCut-out dimensions: Download www.alape.com**EB . R800H**

Built-in basin, rectangular, w/h/d 800/120/500 mm, glazed steel, with one tap hole, with overflow, included fixing set, overflow set

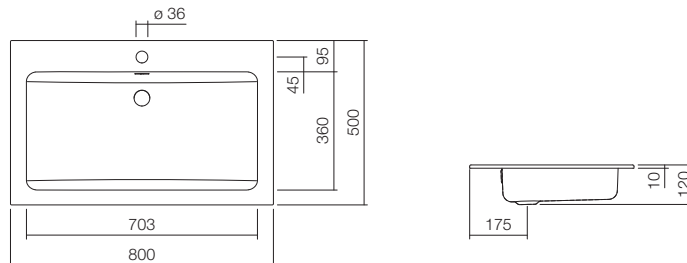
**Art. No.**

white, ProShield

2204 200 000

Version

Without tap hole
3 Drill holes
Drill hole for lotion dispenser
Glossy, matt, special colour

Fittings information

Impact area approx. 185 – 240 mm from middle of tap hole.
For parameters, see page 20.

Recommended miscellaneous

Bottle trap, Sl.2
Bottle trap, Sl.3
Drain valve, VT.1
Angle valve cover, EV.3

Art. No.

8306 000 978
8312 000 978
8302 000 978
8110 000 978

EB . R800H

Built-in basin, rectangular, w/h/d 800/120/500 mm, glazed steel, with one tap hole, without overflow, included fixing set

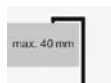
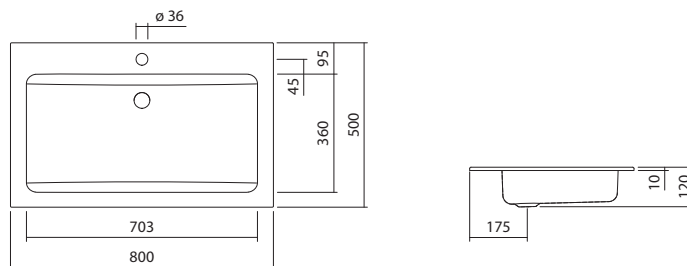
**Art. No.**

white, ProShield

2204 000 000

Version

Without tap hole
3 Drill holes
Drill hole for lotion dispenser
Glossy, matt, special colour

Fittings information

Impact area approx. 185 – 240 mm from middle of tap hole.
For parameters, see page 20.

Recommended miscellaneous

Bottle trap, Sl.2
Bottle trap, Sl.3
Drain valve, VT.3
Angle valve cover, EV.3

Art. No.

8306 000 978
8312 000 978
8305 000 000
8110 000 978

Built-in basins – R-seriesCut-out dimensions: Download www.alape.com**EB . R800**

Built-in basin, rectangular, w/h/d 800/121/450 mm, glazed steel, without tap hole, with overflow, included fixing set, overflow set

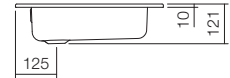
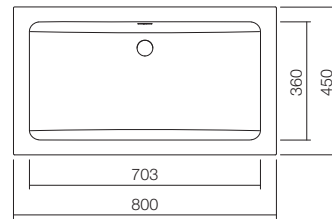

Art. No.
white, ProShield 2203 200 000

Version
Glossy, matt, special colour

Fittings information

Impact area approx. 185 – 240 mm from rear edge of basin.
For parameters, see page 20.

Recommended miscellaneous

Bottle trap, SI.2
Bottle trap, SI.3
Drain valve, VT.1

Art. No.

8306 000 978
8312 000 978
8302 000 978

EB . R800

Built-in basin, rectangular, w/h/d 800/121/450 mm, glazed steel, without tap hole, without overflow, included fixing set

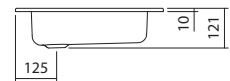
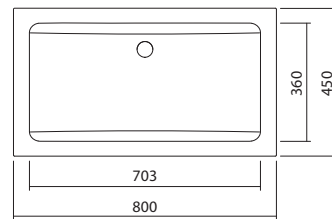

Art. No.
white, ProShield 2203 000 000

Version
Glossy, matt, special colour

Fittings information

Impact area approx. 185 – 240 mm from rear edge of basin.
For parameters, see page 20.

Recommended miscellaneous

Bottle trap, SI.2
Bottle trap, SI.3
Drain valve, VT.3

Art. No.

8306 000 978
8312 000 978
8305 000 000

Built-in basins – RE-series (X.plicit)Cut-out dimensions: Download www.alape.com**EB . RE700H . 2**

Built-in basin, rectangular, w/h/d 700/90/460 mm, glazed steel, with one tap hole, without overflow, included fixing set, drain valve, valve cap, white glazed, w/d 68/68 mm

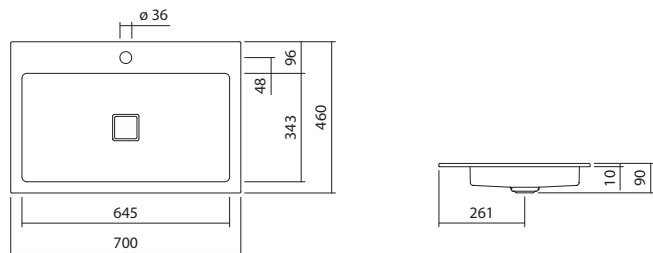

	Art. No.
white, ProShield	2208 000 000

Version
Without tap hole
3 Drill holes
Drill hole for lotion dispenser
Glossy, matt, special colour

Fittings information
Impact area approx. 120 – 150 mm from middle of tap hole.
For parameters, see page 20.

Recommended miscellaneous	Art. No.
Bottle trap, Sl.2	8306 000 978
Bottle trap, Sl.3	8312 000 978
Angle valve cover, EV.3	8110 000 978

EB . RE700 . 4

Built-in basin, rectangular, w/h/d 700/90/398 mm, glazed steel, without tap hole, without overflow, included fixing set, drain valve, valve cap, white glazed, w/d 68/68 mm

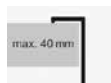
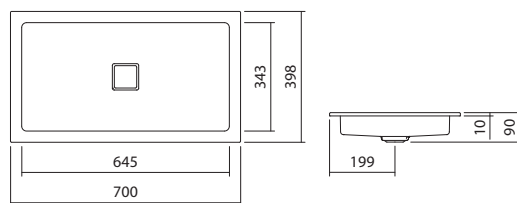

	Art. No.
white, ProShield	2207 000 000

Version
Glossy, matt, special colour

Fittings information
Impact area approx. 105 – 140 mm from rear edge of basin.
For parameters, see page 20.

Recommended miscellaneous	Art. No.
Bottle trap, Sl.2	8306 000 978
Bottle trap, Sl.3	8312 000 978

Built-in basins – Q-series

Cut-out dimensions: Download www.alape.com

EB . Q450H



Built-in basin, rectangular, w/h/d 450/94/500 mm, glazed steel, with one tap hole, without overflow, included fixing set, drain valve, valve cap, white glazed, w/d 68/68 mm

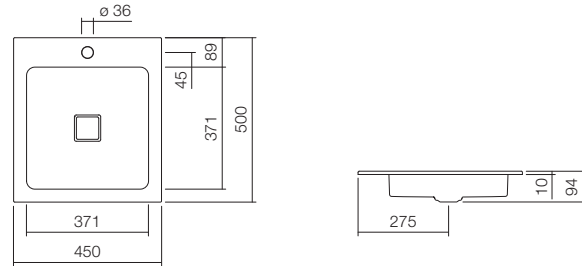

Art. No.

white, ProShield

2303 000 000

Version

3 Drill holes
Drill hole for lotion dispenser
Glossy, matt, special colour

Fittings information

Impact area approx. 120 – 175 mm from middle of tap hole.
For parameters, see page 20.

Recommended miscellaneous

Bottle trap, Sl.2
Bottle trap, Sl.3
Angle valve cover, EV.3

Art. No.

8306 000 978
8312 000 978
8110 000 978

EB . Q450



Built-in basin, square, w/h/d 450/94/450 mm, glazed steel, without tap hole, without overflow, included fixing set, drain valve, valve cap, white glazed, w/d 68/68 mm

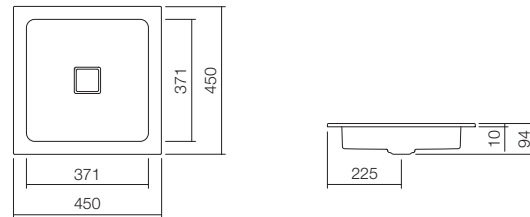

Art. No.

white, ProShield

2302 000 000

Version

Glossy, matt, special colour

Fittings information

Impact area approx. 115 – 170 mm from rear edge of basin.
For parameters, see page 20.

Recommended miscellaneous

Bottle trap, Sl.2
Bottle trap, Sl.3

Art. No.

8306 000 978
8312 000 978

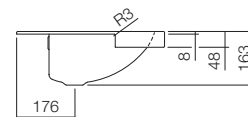
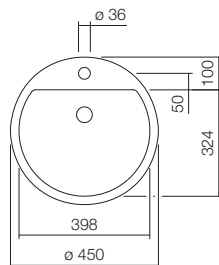
Semi recessed basins – S-series, R-seriesCut-out dimensions: Download www.alape.com**HB . S450H**

Semi-recessed basin, round, Ø 450 mm, height 163 mm, glazed steel, with one tap hole, with overflow, included fixing set, overflow set

	Art. No.
white, ProShield	2900 000 000

Fittings information

Impact area approx. 170 – 210 mm from middle of tap hole.
For parameters, see page 20.

Version

Without tap hole
Without overflow
3 Drill holes
Drill hole for lotion dispenser
Glossy, matt, special colour

Recommended miscellaneous

Bottle trap, Sl.2
Bottle trap, Sl.3
Drain valve, VT.1
Angle valve cover, EV.3

Art. No.

8306 000 978
8312 000 978
8302 000 978
8110 000 978

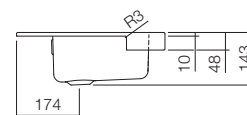
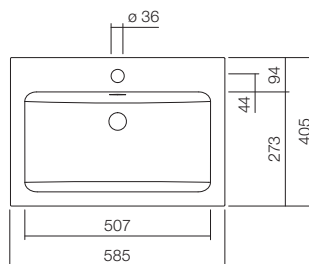
HB . R585H

Semi-recessed basin, rectangular, w/h/d 585/143/405 mm, glazed steel, with one tap hole, with overflow, included fixing set, overflow set

	Art. No.
white, ProShield	2700 000 000

Fittings information

Impact area approx. 170 – 190 mm from middle of tap hole.
For parameters, see page 20.

Version

Without tap hole
Without overflow
3 Drill holes
Drill hole for lotion dispenser
Glossy, matt, special colour

Recommended miscellaneous

Bottle trap, Sl.2
Bottle trap, Sl.3
Drain valve, VT.1
Angle valve cover, EV.3

Art. No.

8306 000 978
8312 000 978
8302 000 978
8110 000 978





















Metaphor
 Built-in basin
EB.ME500
 500 x 111 x 375mm

Sit-on basins

AB



Unisono
Sit-on basin
AB . KE400
ø 400 mm x 116mm

Basin width			
325 – 375 mm	400 – 700 mm	750 – 1000 mm	
 <p>AB . KE325 ø 325 mm, height 105 mm Page 66</p>	 <p>AB . KE400 ø 400 mm, height 116 mm Page 67</p>	 <p>AB . S0450 . 1 ø 450 mm, height 119 mm Page 68</p>	
 <p>AB . KE375 ø 375 mm, height 116 mm Page 66</p>	 <p>AB . S0400 . 1 ø 400 mm, height 102 mm Page 68</p>		
Round			
	 <p>AB . ME500 500 x 375 mm, height 115 mm Page 69</p>	 <p>AB . SR650 650 x 415 mm, height 50 mm Page 71</p>	 <p>AB . ME750 750 x 375 mm, height 115 mm Page 69</p>
	 <p>AB . R585 . 1 585 x 346 mm, height 60 mm Page 72</p>	 <p>AB . SR650H 650 x 472 mm, height 50 mm Page 71</p>	 <p>AB . R800 800 x 455 mm, height 75 mm Page 73</p>
	 <p>AB . R585H . 1 585 x 405 mm, height 60 mm Page 72</p>	 <p>AB . RE700H . 2 700 x 460 mm, height 75 mm Page 74</p>	 <p>AB . R800H 800 x 500 mm, height 75 mm Page 73</p>
	 <p>AB . Q450 . 1 450 x 450 mm, height 110 mm Page 75</p>	 <p>AB . RE700 . 4 700 x 398 mm, height 75 mm Page 74</p>	 <p>AB . ME1000 1000 x 375 mm, height 115 mm Page 70</p>
	 <p>AB . Q450H . 1 450 x 500 mm, height 110 mm Page 75</p>		
Square and rectangular			

Sit-on basins – KE-series (Unisono)Cut-out dimensions: Download www.alape.com**AB . KE325****Price reduction**

Sit-on basin, round, Ø 325 mm, height 106 mm, glazed steel, without tap hole, without overflow, included fixing set, drain valve, valve cap, chrome-plated, Ø 63 mm, black spacer ring

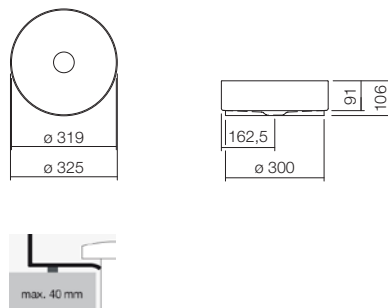
**Art. No.**

white, ProShield

3220 000 000

Version

Glossy, matt, special colour

Fittings information

Impact area approx. 85 – 120 mm from rear edge of basin.
For parameters, see page 20.

Recommended miscellaneous

Bottle trap, Sl.2
Bottle trap, Sl.3

Art. No.

8306 000 978
8312 000 978

AB . KE375**Price reduction**

Sit-on basin, round, Ø 375 mm, height 116 mm, glazed steel, without tap hole, without overflow, included fixing set, drain valve, valve cap, chrome-plated, Ø 74 mm, black spacer ring

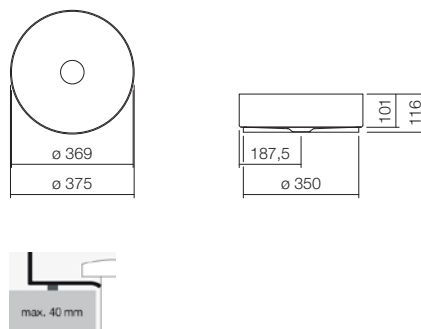
**Art. No.**

white, ProShield

3221 000 000

Version

Glossy, matt, special colour

Fittings information

Impact area approx. 100 – 145 mm from rear edge of basin.
For parameters, see page 20.

Recommended miscellaneous

Bottle trap, Sl.2
Bottle trap, Sl.3

Art. No.

8306 000 978
8312 000 978

Sit-on basins – KE-series (Unisono)Cut-out dimensions: Download www.alape.com**AB . KE400****Price reduction**

Sit-on basin, round, Ø 400 mm, height 116 mm, glazed steel, without tap hole, without overflow, included fixing set, drain valve, valve cap, chrome-plated, Ø 74 mm, black spacer ring

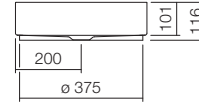
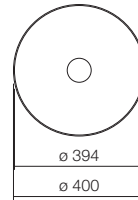
**Art. No.**

white, ProShield
bicolor > see chapter: Special glazes
matt black > see chapter: Special glazes

3222 000 000

Version

Glossy, matt, special colour

Fittings information

Impact area approx. 105 – 150 mm from rear edge of basin.
For parameters, see page 20.

Recommended miscellaneous

Bottle trap, Sl.2
Bottle trap, Sl.3

Art. No.

8306 000 978
8312 000 978

Sit-on basins – SO-series

Cut-out dimensions: Download www.alape.com

AB . S0400 . 1

Price reduction



Sit-on basin, round, Ø 400 mm, height 102 mm, glazed steel, without tap hole, without overflow, included fixing set, drain valve, valve cap, chrome-plated, Ø 74 mm, white spacer ring

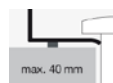
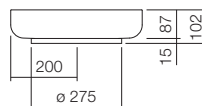
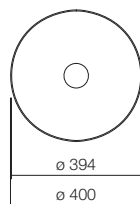

Art. No.

white, ProShield
bicolor > see chapter: Special glazes
dark iron > see chapter: Special glazes
matt black > see chapter: Special glazes

3509 000 000

Version

Glossy, matt, special colour

Fittings information

Impact area approx. 60 – 150 mm from rear edge of basin.
For parameters, see page 20.

Recommended miscellaneous

Bottle trap, Sl.2
Bottle trap, Sl.3

Art. No.

8306 000 978
8312 000 978

AB . S0450 . 1

Price reduction



Sit-on basin, round, Ø 450 mm, height 119 mm, glazed steel, without tap hole, without overflow, included fixing set, drain valve, valve cap, chrome-plated, Ø 74 mm, white spacer ring

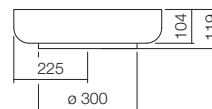
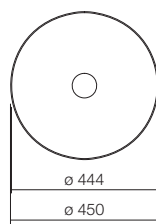

Art. No.

white, ProShield
bicolor > see chapter: Special glazes
dark iron > see chapter: Special glazes
matt black > see chapter: Special glazes

3503 000 000

Version

Glossy, matt, special colour

Fittings information

Impact area approx. 60 – 170 mm from rear edge of basin.
For parameters, see page 20.

Recommended miscellaneous

Bottle trap, Sl.2
Bottle trap, Sl.3

Art. No.

8306 000 978
8312 000 978

Sit-on basins – ME-series (Metaphor)Cut-out dimensions: Download www.alape.com**AB . ME500****Price reduction**

Sit-on basin, rectangular, w/h/d 500/115/375 mm, glazed steel, without tap hole, without overflow, included fixing set, drain valve, valve cap, chrome-plated, Ø 63 mm, black spacer frame

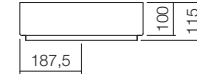
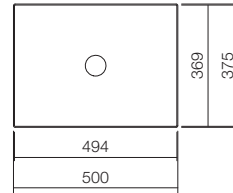

	Art. No.
white, ProShield	3212 000 000

Version	
Glossy, matt, special colour	

Fittings information

Impact area approx. 90 – 135 mm from rear edge of basin.
For parameters, see page 20.

Recommended miscellaneous

	Art. No.
Bottle trap, Sl.2	8306 000 978
Bottle trap, Sl.3	8312 000 978

AB . ME750**Price reduction**

Sit-on basin, rectangular, w/h/d 750/115/375 mm, glazed steel, without tap hole, without overflow, included fixing set, drain valve, valve cap, chrome-plated, Ø 63 mm, black spacer frame

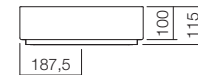
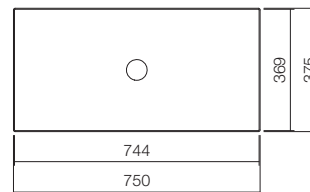

	Art. No.
white, ProShield	3213 000 000

Version	
Glossy, matt, special colour	

Fittings information

Impact area approx. 90 – 135 mm from rear edge of basin.
For parameters, see page 20.

Recommended miscellaneous

	Art. No.
Bottle trap, Sl.2	8306 000 978
Bottle trap, Sl.3	8312 000 978

Sit-on basins – ME-series (Metaphor)Cut-out dimensions: Download www.alape.com**AB . ME1000****Price reduction**

Sit-on basin, rectangular, w/h/d 1000/115/375 mm, glazed steel, without tap hole, without overflow, included fixing set, drain valve, valve cap, chrome-plated, Ø 63 mm, black spacer frame

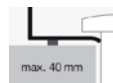
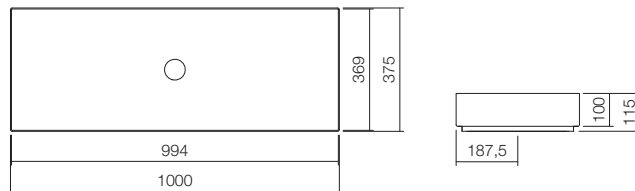
**Art. No.**

white, ProShield

3214 000 000

Version

Glossy, matt, special colour

Fittings information

Impact area approx. 90 – 135 mm from rear edge of basin.
For parameters, see page 20.

Recommended miscellaneous

Bottle trap, Sl.2
Bottle trap, Sl.3

Art. No.

8306 000 978
8312 000 978

Sit-on basins – SR-series (Stream)

Cut-out dimensions: Download www.alape.com

AB . SR650H

Price reduction



Sit-on basin, rectangular, w/h/d 650/127/472 mm, glazed steel, with one tap hole, with overflow, included fixing set, overflow set

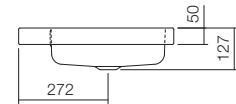
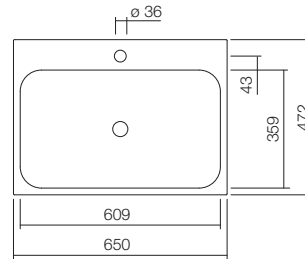

	Art. No.
white, ProShield	3231 600 000

Fittings information

Impact area approx. 105 – 155 mm from middle of tap hole.
For parameters, see page 20.

Version	
Without overflow	
3 Drill holes	
Drill hole for lotion dispenser	
Glossy, matt, special colour	

Recommended miscellaneous	Art. No.
Bottle trap, Sl.2	8306 000 978
Bottle trap, Sl.3	8312 000 978
Drain valve, VT.1	8302 000 978
Angle valve cover, EV.3	8110 000 978

AB . SR650

Price reduction



Sit-on basin, rectangular, w/h/d 650/127/415 mm, glazed steel, without tap hole, with overflow, included fixing set, overflow set

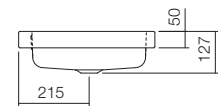
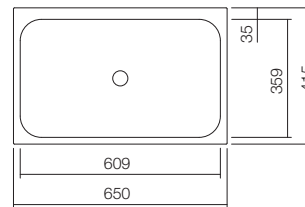

	Art. No.
white, ProShield	3230 700 000

Fittings information

Impact area approx. 98 – 148 mm from rear edge of basin.
For parameters, see page 20.

Version	
Without overflow	
Glossy, matt, special colour	

Recommended miscellaneous	Art. No.
Bottle trap, Sl.2	8306 000 978
Bottle trap, Sl.3	8312 000 978
Drain valve, VT.1	8302 000 978

Sit-on basins – R-seriesCut-out dimensions: Download www.alape.com**AB . R585H . 1****Price reduction**

Sit-on basin, rectangular, w/h/d 585/143/405 mm, glazed steel, with one tap hole, with overflow, included fixing set, overflow set

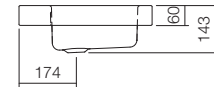
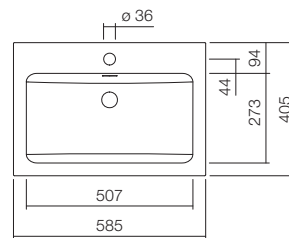
**Art. No.**

white, ProShield

3202 000 000

Version

Without overflow
3 Drill holes
Drill hole for lotion dispenser
Glossy, matt, special colour

Fittings information

Impact area approx. 170 – 190 mm from middle of tap hole.
For parameters, see page 20.

Recommended miscellaneous**Art. No.**

Bottle trap, Sl.2	8306 000 978
Bottle trap, Sl.3	8312 000 978
Drain valve, VT.1	8302 000 978
Angle valve cover, EV.3	8110 000 978

AB . R585 . 1**Price reduction**

Sit-on basin, rectangular, w/h/d 585/143/346 mm, glazed steel, without tap hole, with overflow, included fixing set, overflow set

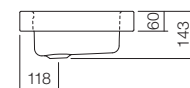
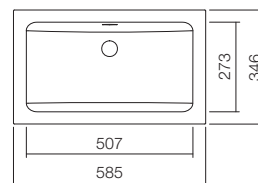
**Art. No.**

white, ProShield

3205 000 000

Version

Without overflow
Glossy, matt, special colour

Fittings information

Impact area approx. 160 – 180 mm from rear edge of basin.
For parameters, see page 20.

Recommended miscellaneous**Art. No.**

Bottle trap, Sl.2	8306 000 978
Bottle trap, Sl.3	8312 000 978
Drain valve, VT.1	8302 000 978

Sit-on basins – R-series

Cut-out dimensions: Download www.alape.com

AB . R800H

Price reduction



Sit-on basin, rectangular, w/h/d 800/120/500 mm, glazed steel, with one tap hole, with overflow, included fixing set, overflow set

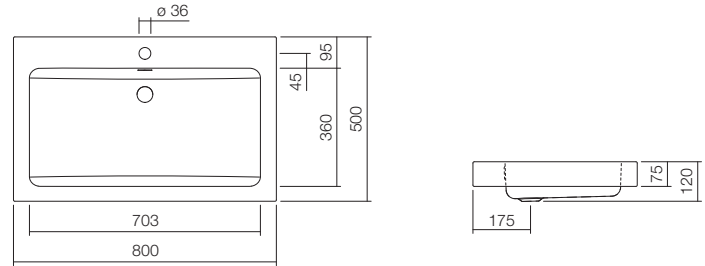

Art. No.

white, ProShield

3206 200 000

Version

Without overflow
3 Drill holes
Drill hole for lotion dispenser
Glossy, matt, special colour

Fittings information

Impact area approx. 185 – 240 mm from middle of tap hole.
For parameters, see page 20.

Recommended miscellaneous

Bottle trap, Sl.2
Bottle trap, Sl.3
Drain valve, VT.1
Angle valve cover, EV.3

Art. No.

8306 000 978
8312 000 978
8302 000 978
8110 000 978

AB . R800

Price reduction



Sit-on basin, rectangular, w/h/d 800/120/455 mm, glazed steel, without tap hole, with overflow, included fixing set, overflow set

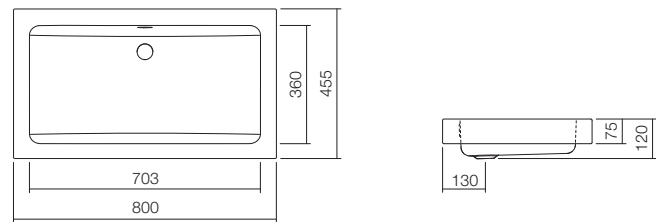

Art. No.

white, ProShield

3207 200 000

Version

Without overflow
Glossy, matt, special colour

Fittings information

Impact area approx. 190 – 245 mm from rear edge of basin.
For parameters, see page 20.

Recommended miscellaneous

Bottle trap, Sl.2
Bottle trap, Sl.3
Drain valve, VT.1

Art. No.

8306 000 978
8312 000 978
8302 000 978

Sit-on basins – RE-series (X.plicit)Cut-out dimensions: Download www.alape.com**AB . RE700H . 2****Price reduction**

Sit-on basin, rectangular, w/h/d 700/90/460 mm, glazed steel, with one tap hole, without overflow, included fixing set, drain valve, valve cap, white glazed, w/d 68/68 mm

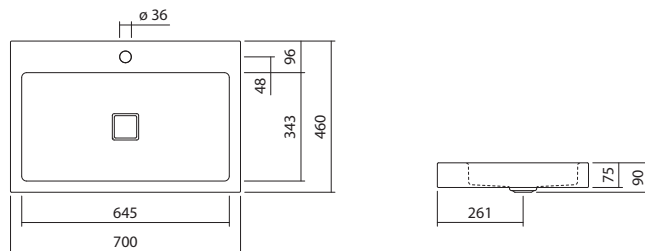
**Art. No.**

white, ProShield

3209 000 000

Version

Without tap hole
3 Drill holes
Drill hole for lotion dispenser
Glossy, matt, special colour

Fittings information

Impact area approx. 120 – 150 mm from middle of tap hole.
For parameters, see page 20.

Recommended miscellaneous

Bottle trap, Sl.2
Bottle trap, Sl.3
Angle valve cover, EV.3

Art. No.

8306 000 978
8312 000 978
8110 000 978

AB . RE700 . 4**Price reduction**

Sit-on basin, rectangular, w/h/d 700/90/398 mm, glazed steel, without tap hole, without overflow, included fixing set, drain valve, valve cap, white glazed, w/d 68/68 mm

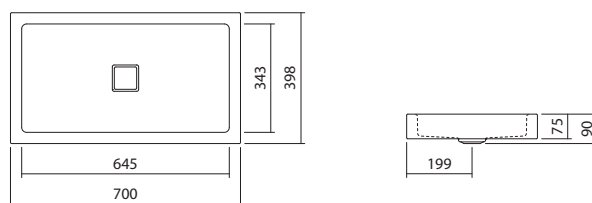
**Art. No.**

white, ProShield

3208 000 000

Version

Glossy, matt, special colour

Fittings information

Impact area approx. 105 – 140 mm from rear edge of basin.
For parameters, see page 20.

Recommended miscellaneous

Bottle trap, Sl.2
Bottle trap, Sl.3

Art. No.

8306 000 978
8312 000 978

Sit-on basins – Q-series

Cut-out dimensions: Download www.alape.com

AB . Q450H . 1

Price reduction



Sit-on basin, rectangular, w/h/d 450/110/500 mm, glazed steel, with one tap hole, without overflow, included fixing set, drain valve, valve cap, white glazed, w/d 68/68 mm

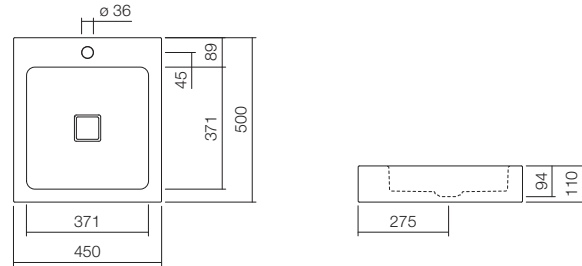

Art. No.

white, ProShield

3304 000 000

Version

3 Drill holes
Drill hole for lotion dispenser
Glossy, matt, special colour

Fittings information

Impact area approx. 120 – 175 mm from middle of tap hole.
For parameters, see page 20.

Recommended miscellaneous

Bottle trap, Sl.2
Bottle trap, Sl.3
Angle valve cover, EV.3

Art. No.

8306 000 978
8312 000 978
8110 000 978

AB . Q450 . 1

Price reduction



Sit-on basin, square, w/h/d 450/110/450 mm, glazed steel, without tap hole, without overflow, included fixing set, drain valve, valve cap, white glazed, w/d 68/68 mm

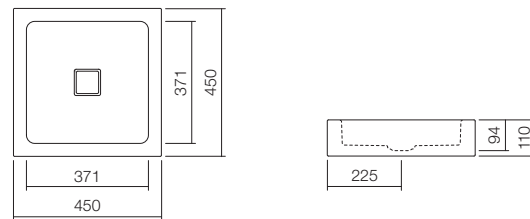

Art. No.

white, ProShield

3302 000 000

Version

Glossy, matt, special colour

Fittings information

Impact area approx. 115 – 170 mm from rear edge of basin.
For parameters, see page 20.

Recommended miscellaneous

Bottle trap, Sl.2
Bottle trap, Sl.3

Art. No.





8306 000 978
8312 000 978

Dish Basins

SB



Scopio
Dish basin
SB . C0375
ø 375 x 115mm

		Basin width				
		325 – 425mm	450 – 585mm	600 – 700mm	800 – 1000mm	
Round	 <p>SB . K300 . GS ø 300mm Page 78</p>	 <p>SB . K450 . GS ø 450mm Page 79</p>				
	 <p>SB . K360 . GS ø 360mm Page 78</p>					
	 <p>SB . C0375 ø 375mm Page 79</p>					
Oval			 <p>SB . 0700 . GS 703 x 403mm Page 80</p>			
Square and rectangular			 <p>SB . SR650 599 x 349mm Page 80</p>			

Dish basins – GS-series

Cut-out dimensions: Download www.alape.com

SB . K300 . GS

Price reduction



Dish basin, round, Ø 300 mm, height 110 mm, glazed steel, without tap hole, without overflow, included drain valve, valve cap, chrome-plated, Ø 63 mm, chrome-plated spacer ring

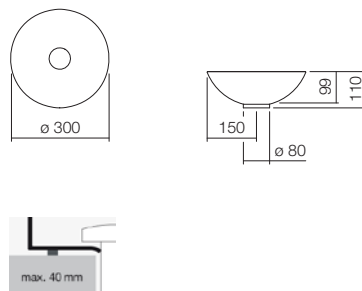

Art. No.

white, ProShield

3500 000 000

Version

Glossy, matt, special colour

Fittings information

Impact area approx. 80 – 110 mm from rear edge of basin.
For parameters, see page 20.

Recommended miscellaneous

Bottle trap, Sl.2
Bottle trap, Sl.3

Art. No.

8306 000 978
8312 000 978

SB . K360 . GS

Price reduction

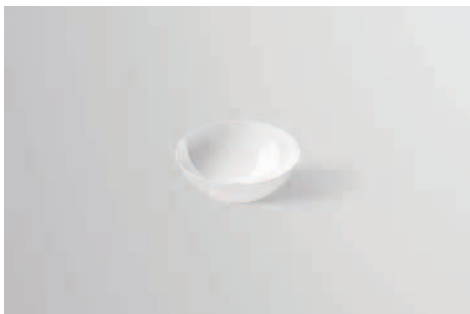

Dish basin, round, Ø 360 mm, height 130 mm, glazed steel, without tap hole, without overflow, included drain valve, valve cap, chrome-plated, Ø 63 mm, chrome-plated spacer ring

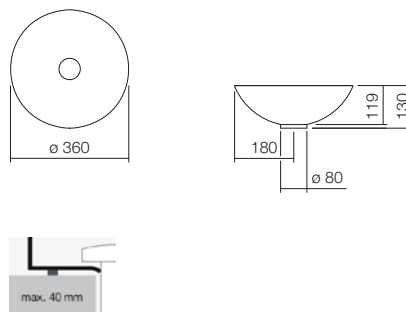

Art. No.

white, ProShield

3501 000 000

bicolor > see chapter: Special glazes
dark iron > see chapter: Special glazes
matt black > see chapter: Special glazes

Version

Glossy, matt, special colour

Fittings information

Impact area approx. 100 – 140 mm from rear edge of basin.
For parameters, see page 20.

Recommended miscellaneous

Bottle trap, Sl.2
Bottle trap, Sl.3

Art. No.

8306 000 978
8312 000 978

Dish basins – GS-series, CO-series

Cut-out dimensions: Download www.alape.com

SB . K450 . GS

Price reduction



Dish basin, round, Ø 450 mm, height 142 mm, glazed steel, without tap hole, without overflow, included drain valve, valve cap, chrome-plated, Ø 74 mm, chrome-plated spacer ring

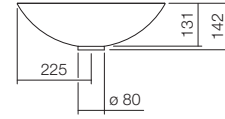
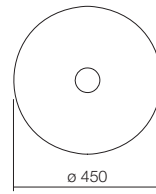

Art. No.
white, ProShield 3502 000 000

Version
Glossy, matt, special colour

Fittings information

Impact area approx. 130 – 180 mm from rear edge of basin.
For parameters, see page 20.

Recommended miscellaneous

Bottle trap, Sl.2
Bottle trap, Sl.3

Art. No.

8306 000 978
8312 000 978

SB . C0375

Price reduction



Dish basin, round, Ø 375 mm, height 115 mm, glazed steel, without tap hole, without overflow, included drain valve, valve cap, white glazed, Ø 74 mm, black spacer ring

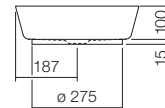
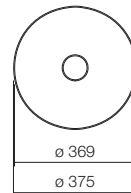

Art. No.
white, ProShield 3508 500 000

Version
Glossy, matt, special colour

Fittings information

Impact area approx. 100 – 135 mm from rear edge of basin.
For parameters, see page 20.

Recommended miscellaneous

Bottle trap, Sl.2
Bottle trap, Sl.3

Art. No.

8306 000 978
8312 000 978

Dish basins – GS-series, SR-seriesCut-out dimensions: Download www.alape.com**SB . 0700 . GS****Price reduction**

Dish basin, oval, w/h/d 703/85/403 mm, glazed steel, without tap hole, without overflow, included drain valve, valve cap, white glazed, w/d 390/90 mm, white spacer frame

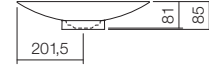
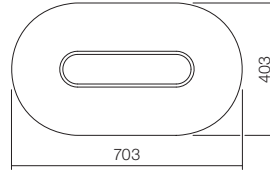
**Art. No.**

white, ProShield

3520 000 000

Version

Glossy, matt, special colour

Fittings information

Impact area approx. 120 – 150 mm from rear edge of basin.
For parameters, see page 20.

Recommended miscellaneous

Bottle trap, Sl.2
Bottle trap, Sl.3

Art. No.

8306 000 978
8312 000 978

SB . SR650**Price reduction**

Dish basin, rectangular, w/h/d 599/118/349 mm, glazed steel, without tap hole, without overflow, included drain valve, valve cap, chrome-plated, Ø 74 mm, chrome-plated spacer frame

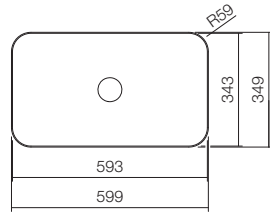
**Art. No.**

white, ProShield

3507 500 000

matt black > see chapter: Special glazes
terra > see chapter: Special glazes

Version

Glossy, matt, special colour

Fittings information

Impact area approx. 58 – 108 mm from rear edge of basin.
For parameters, see page 20.

Recommended miscellaneous

Bottle trap, Sl.2
Bottle trap, Sl.3

Art. No.

8306 000 978
8312 000 978



























Stream
Dish basin
SB.SR650
599 x 118 x 349mm

Special glazes



Aqua
Dish basin

		Basin width						
		300 – 425 mm	450 – 600 mm					
 SB. Aqua300 ø 300 mm Seite 84	 UB. K400 Mulde ø 359 mm Seite 94	 SB. Aqua450 ø 450 mm Seite 85	 SB. Terra450 ø 450 mm Seite 87	Round				
					 SB. Terra300 ø 300 mm Seite 86	 AB. KE400 ø 400 mm Seite 88/91	 AB. S0450.1 ø 400 mm Seite 89/92/95	 AB. S0400.1 ø 400 mm Seite 88/91/95
					 SB. Aqua360 ø 360 mm Seite 84	 (Empty)	 AB. S0450.1 ø 400 mm Seite 89/92/95	 (Empty)
					 SB. Terra360 ø 360 mm Seite 86	 (Empty)	 AB. S0450.1 ø 400 mm Seite 89/92/95	 (Empty)
					 SB. K360.GS ø 360 mm Seite 89/92/96	 (Empty)	 AB. S0450.1 ø 400 mm Seite 89/92/95	 (Empty)
			 WT. RX400.K ø 400 mm Seite 96	Columns				
			 WT. RX400.KE ø 400 mm Seite 90					
			 UB. 0525 Mulde 472 x 373 mm Seite 94	Oval				
			 SB. SR650 599 x 349 mm Seite 87/93	Rectangle				

AquaCut-out dimensions: Download www.alape.com**SB . Aqua300**

Dish basin, round, Ø 300 mm, height 118 mm, glazed steel, without tap hole, without overflow, included drain valve, valve cap, glazed in the basin colour, Ø 84 mm

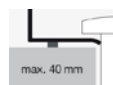
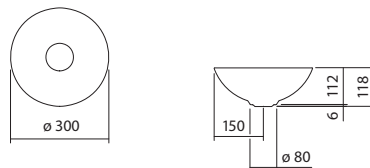

deep green



deep blue



deep indigo

	Art. No.
deep green	3900 000 091
deep blue	3900 000 092
deep indigo	3900 000 093

Recommended miscellaneous	Art. No.
Bottle trap, Sl.2	8306 000 978
Bottle trap, Sl.3	8312 000 978

Fittings information

Impact area approx. 80 – 110 mm from rear edge of basin.
For parameters, see page 20.

SB . Aqua360

Dish basin, round, Ø 360 mm, height 137 mm, glazed steel, without tap hole, without overflow, included drain valve, valve cap, glazed in the basin colour, Ø 84 mm

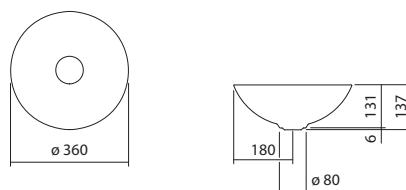

deep green



deep blue



deep indigo

	Art. No.
deep green	3901 000 091
deep blue	3901 000 092
deep indigo	3901 000 093

Recommended miscellaneous	Art. No.
Bottle trap, Sl.2	8306 000 978
Bottle trap, Sl.3	8312 000 978

Fittings information

Impact area approx. 100 – 140 mm from rear edge of basin.
For parameters, see page 20.

AquaCut-out dimensions: Download www.alape.com**SB . Aqua450**

Dish basin, round, Ø 450 mm, height 149 mm, glazed steel, without tap hole, without overflow, included drain valve, valve cap, glazed in the basin colour, Ø 92 mm

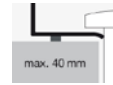
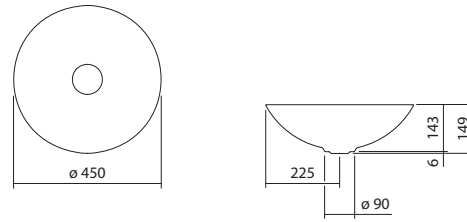

	Art. No.
deep green	3902 000 091
deep blue	3902 000 092
deep indigo	3902 000 093

Recommended miscellaneous	Art. No.
Bottle trap, Sl.2	8306 000 978
Bottle trap, Sl.3	8312 000 978

Fittings information

Impact area approx. 130 – 180 mm from rear edge of basin.
For parameters, see page 20.

SB . Terra300

Dish basin, round, Ø 300 mm, height 118 mm, glazed steel, without tap hole, without overflow, included drain valve, valve cap, glazed in the basin colour, Ø 84 mm

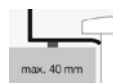
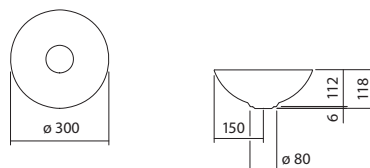

oyster matt



silk matt



nordic matt



gravel matt

	Art. No.
oyster matt	3900 000 081
silk matt	3900 000 082
nordic matt	3900 000 083
gravel matt	3900 000 084

Recommended miscellaneous	Art. No.
Bottle trap, Sl.2	8306 000 978
Bottle trap, Sl.3	8312 000 978

Fittings information

Impact area approx. 80 – 110 mm from rear edge of basin.
For parameters, see page 20.

SB . Terra360

Dish basin, round, Ø 360 mm, height 137 mm, glazed steel, without tap hole, without overflow, included drain valve, valve cap, glazed in the basin colour, Ø 84 mm

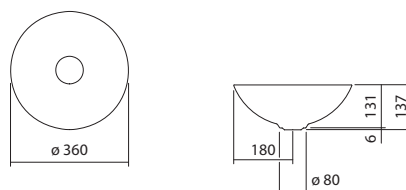

oyster matt



silk matt



nordic matt



gravel matt

	Art. No.
oyster matt	3901 000 081
silk matt	3901 000 082
nordic matt	3901 000 083
gravel matt	3901 000 084

Recommended miscellaneous	Art. No.
Bottle trap, Sl.2	8306 000 978
Bottle trap, Sl.3	8312 000 978

Fittings information

Impact area approx. 100 – 140 mm from rear edge of basin.
For parameters, see page 20.

Terra

Cut-out dimensions: Download www.alape.com

SB . Terra450



Dish basin, round, Ø 450 mm, height 149 mm, glazed steel, without tap hole, without overflow, included drain valve, valve cap, glazed in the basin colour, Ø 92 mm

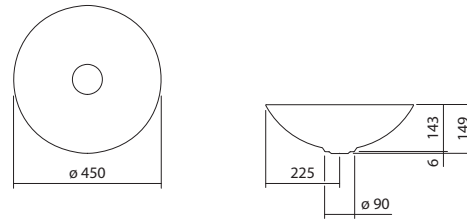

oyster matt



silk matt



nordic matt



gravel matt

	Art. No.
oyster matt	3902 000 081
silk matt	3902 000 082
nordic matt	3902 000 083
gravel matt	3902 000 084

Fittings information

Impact area approx. 130 – 180 mm from rear edge of basin.
For parameters, see page 20.

Recommended miscellaneous

Bottle trap, Sl.2
Bottle trap, Sl.3

Art. No.

8306 000 978
8312 000 978

SB . SR650



Dish basin, rectangular, w/h/d 599/118/349 mm, glazed steel, without tap hole, without overflow, included drain valve, valve cap, glazed in the basin colour, Ø 84 mm, black spacer frame

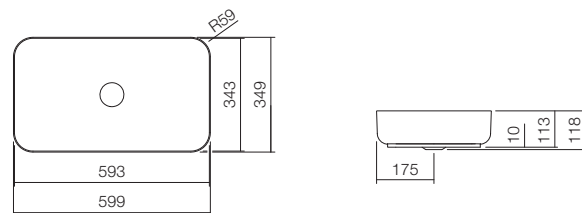

oyster matt



silk matt



nordic matt



gravel matt

	Art. No.
oyster matt	3521 500 081
silk matt	3521 500 082
nordic matt	3521 500 083
gravel matt	3521 500 084

Fittings information

Impact area approx. 58 – 108 mm from rear edge of basin.
For parameters, see page 20.

Recommended miscellaneous

Bottle trap, Sl.2
Bottle trap, Sl.3

Art. No.

8306 000 978
8312 000 978

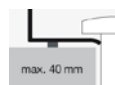
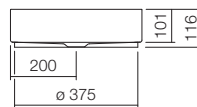
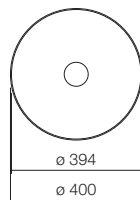
BicolorCut-out dimensions: Download www.alape.com**AB . KE400**

Sit-on basin, round, Ø 400 mm, height 116 mm, glazed steel, matte black/glossy white, without tap hole, without overflow, included fixing set, drain valve, valve cap, white glazed, Ø 74 mm, black spacer ring

	Art. No.
matte black/glossy white	3222 000 180

Recommended miscellaneous	Art. No.
Bottle trap, Sl.2	8306 000 978
Bottle trap, Sl.3	8312 000 978

Fittings information

Impact area approx. 105 – 150 mm from rear edge of basin.
For parameters, see page 20.

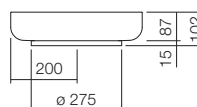
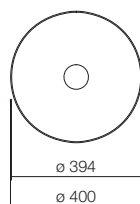
AB . S0400 . 1

Sit-on basin, round, Ø 400 mm, height 102 mm, glazed steel, matte black/glossy white, without tap hole, without overflow, included fixing set, drain valve, valve cap, white glazed, Ø 74 mm, black spacer ring

	Art. No.
matte black/glossy white	3509 000 180

Recommended miscellaneous	Art. No.
Bottle trap, Sl.2	8306 000 978
Bottle trap, Sl.3	8312 000 978

Fittings information

Impact area approx. 60 – 150 mm from rear edge of basin.
For parameters, see page 20.

BicolorCut-out dimensions: Download www.alape.com**AB.S0450.1**

Sit-on basin, round, Ø 450 mm, height 119 mm, glazed steel, matte black/glossy white, without tap hole, without overflow, included fixing set, drain valve, valve cap, white glazed, Ø 74 mm, black spacer ring

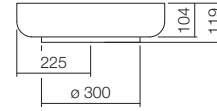
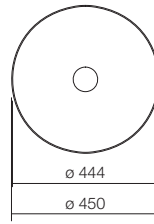

	Art. No.
matte black/glossy white	3503 000 180

Recommended miscellaneous	Art. No.
Bottle trap, Sl.2	8306 000 978
Bottle trap, Sl.3	8312 000 978

Fittings information

Impact area approx. 60 – 170 mm from rear edge of basin.
For parameters, see page 20.

SB.K360.GS

Dish basin, round, Ø 360 mm, height 130 mm, glazed steel, matte black/glossy white, without tap hole, without overflow, included drain valve, valve cap, white glazed, Ø 63 mm, black spacer ring

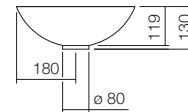
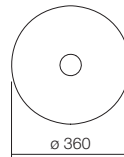

	Art. No.
matte black/glossy white	3501 000 180

Recommended miscellaneous	Art. No.
Bottle trap, Sl.2	8306 000 978
Bottle trap, Sl.3	8312 000 978

Fittings information

Impact area approx. 100 – 140 mm from rear edge of basin.
For parameters, see page 20.

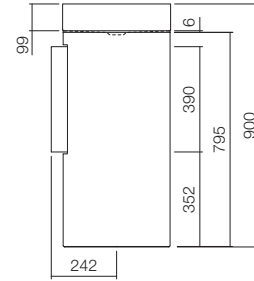
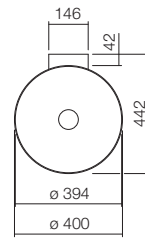
BicolorCut-out dimensions: Download www.alape.com**WT . RX400 . KE**

Washstand, round, w/h/d 400/900/442 mm, sink round, centred, Ø 394 mm, sink depth 99 mm, glazed steel, matte black/glossy white, without tap hole, without overflow, included fixing set, drain valve, valve cap, white glazed, Ø 74 mm, bottle trap, chrome-plated spacer ring, black wall bracket

	Art. No.
matte black/glossy white	4506 500 180

Recommended miscellaneous	Art. No.
Mirror, SP.300	6719 000 899
Mirror, SP.325	6716 000 899

Fittings information

Impact area approx. 147 – 192 mm from rear edge of basin.
For parameters, see page 20.

Matt blackCut-out dimensions: Download www.alape.com**AB . KE400**

Sit-on basin, round, Ø 400 mm, height 116 mm, glazed steel, without tap hole, without overflow, included fixing set, drain valve, valve cap, glazed in the basin colour, Ø 74 mm, black spacer ring

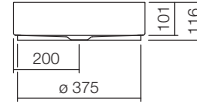
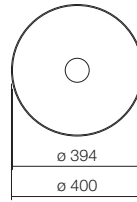

	Art. No.
matt black	3222 000 240

Recommended miscellaneous	Art. No.
Bottle trap, Sl.2	8306 000 978
Bottle trap, Sl.3	8312 000 978

Fittings information

Impact area approx. 105 – 150 mm from rear edge of basin.
For parameters, see page 20.

AB . S0400 . 1

Sit-on basin, round, Ø 400 mm, height 102 mm, glazed steel, without tap hole, without overflow, included fixing set, drain valve, valve cap, glazed in the basin colour, Ø 74 mm, black spacer ring

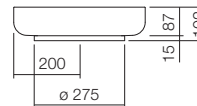
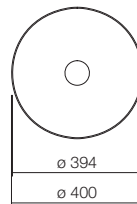

	Art. No.
matt black	3509 000 240

Recommended miscellaneous	Art. No.
Bottle trap, Sl.2	8306 000 978
Bottle trap, Sl.3	8312 000 978

Fittings information

Impact area approx. 60 – 150 mm from rear edge of basin.
For parameters, see page 20.

Matt blackCut-out dimensions: Download www.alape.com**AB.S0450.1**

Sit-on basin, round, Ø 450 mm, height 119 mm, glazed steel, without tap hole, without overflow, included fixing set, drain valve, valve cap, glazed in the basin colour, Ø 74 mm, black spacer ring

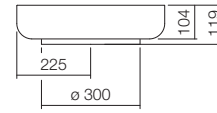
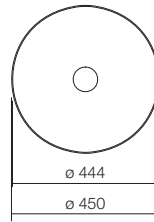

	Art. No.
matt black	3503 000 240

Recommended miscellaneous	Art. No.
Bottle trap, Sl.2	8306 000 978
Bottle trap, Sl.3	8312 000 978

Fittings information

Impact area approx. 60 – 170 mm from rear edge of basin.
For parameters, see page 20.

SB.K360.GS

Dish basin, round, Ø 360 mm, height 130 mm, glazed steel, without tap hole, without overflow, included drain valve, valve cap, glazed in the basin colour, Ø 63 mm, black spacer ring

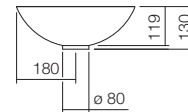
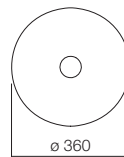

	Art. No.
matt black	3501 000 240

Recommended miscellaneous	Art. No.
Bottle trap, Sl.2	8306 000 978
Bottle trap, Sl.3	8312 000 978

Fittings information

Impact area approx. 100 – 140 mm from rear edge of basin.
For parameters, see page 20.

Matt blackCut-out dimensions: Download www.alape.com**SB . SR650**

Dish basin, rectangular, w/h/d 599/118/349 mm, glazed steel, without tap hole, without overflow, included drain valve, valve cap, glazed in the basin colour, Ø 84 mm, black spacer frame

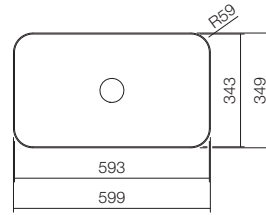

	Art. No.
matt black	3521 500 240

Recommended miscellaneous	Art. No.
Bottle trap, Sl.2	8306 000 978
Bottle trap, Sl.3	8312 000 978

Fittings information

Impact area approx. 58 – 108 mm from rear edge of basin.
For parameters, see page 20.

MetallicCut-out dimensions: Download www.alape.com**UB . K400**

Undermount basin, round, Ø 359 mm, height 140 mm, glazed steel, metallic, without tap hole, without overflow, included fixing set, drain valve, valve cap, metallic dark iron glazed, Ø 74 mm

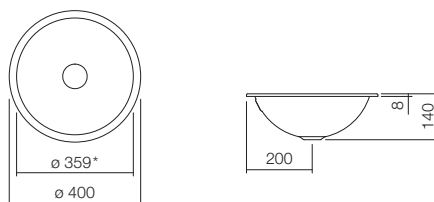
**Art. No.**

dark iron

2031 500 190

Recommended miscellaneous

Bottle trap, Sl.2
Bottle trap, Sl.3

Art. No.

8306 000 978
8312 000 978

Fittings information

Impact area approx. 110 – 150 mm from rear edge of basin.
For parameters, see page 20.

UB . 0525

Undermount basin, oval, w/h/d 481/150/383 mm, glazed steel, metallic, without tap hole, without overflow, included fixing set, drain valve, valve cap, metallic dark iron glazed, Ø 74 mm

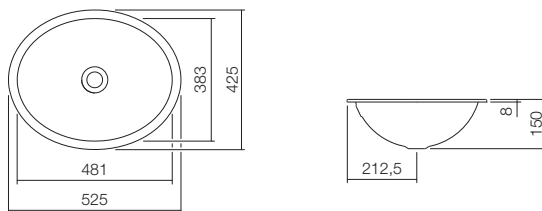
**Art. No.**

dark iron

2111 500 190

Recommended miscellaneous

Bottle trap, Sl.2
Bottle trap, Sl.3

Art. No.

8306 000 978
8312 000 978

Fittings information

Impact area approx. 120 – 165 mm from rear edge of basin.
For parameters, see page 20.

MetallicCut-out dimensions: Download www.alape.com**AB.S0400.1**

Sit-on basin, round, Ø 400 mm, height 102 mm, glazed steel, metallic, without tap hole, without overflow, included fixing set, drain valve, valve cap, metallic dark iron glazed, Ø 74 mm, black spacer ring

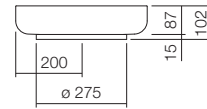
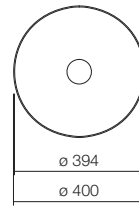

	Art. No.
dark iron	3509 000 190

Recommended miscellaneous	Art. No.
Bottle trap, Sl.2	8306 000 978
Bottle trap, Sl.3	8312 000 978

Fittings information

Impact area approx. 60 – 150 mm from rear edge of basin.
For parameters, see page 20.

AB.S0450.1

Sit-on basin, round, Ø 450 mm, height 119 mm, glazed steel, metallic, without tap hole, without overflow, included fixing set, drain valve, valve cap, metallic dark iron glazed, Ø 74 mm, black spacer ring

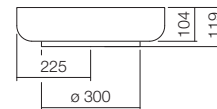
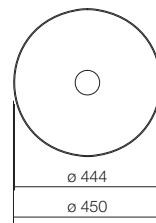

	Art. No.
dark iron	3503 000 190

Recommended miscellaneous	Art. No.
Bottle trap, Sl.2	8306 000 978
Bottle trap, Sl.3	8312 000 978

Fittings information

Impact area approx. 60 – 170 mm from rear edge of basin.
For parameters, see page 20.

MetallicCut-out dimensions: Download www.alape.com**SB . K360 . GS**

Dish basin, round, Ø 360 mm, height 130 mm, glazed steel, metallic, without tap hole, without overflow, included drain valve, valve cap, metallic dark iron glazed, Ø 63 mm, black spacer ring

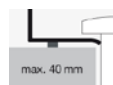
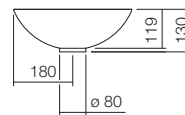
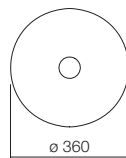

	Art. No.
dark iron	3501 000 190

Recommended miscellaneous	Art. No.
Bottle trap, Sl.2	8306 000 978
Bottle trap, Sl.3	8312 000 978

Fittings information

Impact area approx. 100 – 140 mm from rear edge of basin.
For parameters, see page 20.

WT . RX400K

Washstand, round, w/h/d 404/900/444 mm, sink round, centred, Ø 359 mm, sink depth 140 mm, glazed steel, metallic, without tap hole, without overflow, included fixing set, drain valve, valve cap, metallic dark iron glazed, Ø 63 mm, bottle trap, black wall bracket

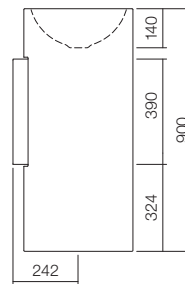
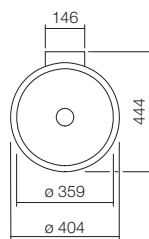

	Art. No.
dark iron	4503 000 190

Recommended miscellaneous	Art. No.
Mirror, SP.300	6719 000 899
Mirror, SP.325	6716 000 899

Fittings information

Impact area approx. 152 – 192 mm from rear edge of basin.
For parameters, see page 20.



Washstand
Metallic Dark Iron
WT.RX400K
404 x 900 x 444mm

Washstands

WT



Scopio
Washstand
WT.RX400H.CO
400 x 900 x 500mm

Basin width

325mm

400 – 600mm

650 – 800mm

1000 – 1250mm

 **WT.RS325**
ø 329mm I.P. 108

 **WT.CO400**
ø 400mm I.P. 110

 **WT.CO400H**
ø 400mm I.P. 110

 **WT.RS400**
ø 400mm I.P. 108

 **WT.RS450**
ø 450mm I.P. 109

 **WT.RX325.KE**
ø 325 mm I.P. 105

 **WT.RX325K**
ø 329 mm I.P. 102

 **WT.RX400.CU**
ø 397 mm | P. 101

 **WT.RX400H.CU**
ø 397 mm | P. 101

 **WT.RX400.CR**
ø 397 mm | P. 100

 **WT.RX400H.CR**
ø 397 mm | P. 100

Columns

 **WT.RX400.KE**
ø 400mm I.P. 105

 **WT.RX400K**
ø 404mm I.P. 103/107

 **WT.RX400KH**
ø 400mm I.P. 102

 **WT.RX400H.CO**
ø 400mm I.P. 104

 **WT.RX400.CO**
ø 400mm I.P. 104

Columns

Round

 **WT.IC325H**
325 x 325mm I.P. 111

 **WT.QS325**
325 x 325mm I.P. 117

 **WT.QS325H**
325 x 385mm I.P. 117

 **WT.QS325X**
329 x 329mm I.P. 118

 **WT.MC450H**
450 x 455mm I.P. 113

 **WT.XXS450.L/R**
450 x 236mm I.P. 115/116

 **WT.XXS450H.L/R**
450 x 236mm I.P. 115/116

 **WT.XS500.L/R**
500 x 268mm I.P. 121/122

 **WT.XS500H.L/R**
500 x 268mm I.P. 121/122

 **WT.QS525.L/R**
525 x 325mm I.P. 119/120

 **WT.QS525H.L/R**
525 x 325mm I.P. 118/119

 **WT.PR585**
585 x 347mm I.P. 124

 **WT.PR585H**
585 x 405mm I.P. 124

 **WT.IC600H**
600 x 325mm I.P. 111

 **WT.IC600H.L/R**
600 x 325mm I.P. 112

 **WT.SR800H.L/R**
800 x 472mm I.P. 123

 **WT.MC800H**
800 x 455mm I.P. 113

 **WT.MC800H.L/R**
800 x 455mm I.P. 114

 **WT.PR800**
800 x 405mm I.P. 125

 **WT.PR800H**
800 x 405mm I.P. 125

 **WT.PR800.L/R**
800 x 405mm I.P. 126/127

 **WT.PR800H.L/R**
800 x 405mm I.P. 126/127

Square and rectangular

 **WT.RX325QS**
329 x 329mm P. 106

Columns

 **WT.RX450QS**
455 x 455mm I.P. 106/107

Columns

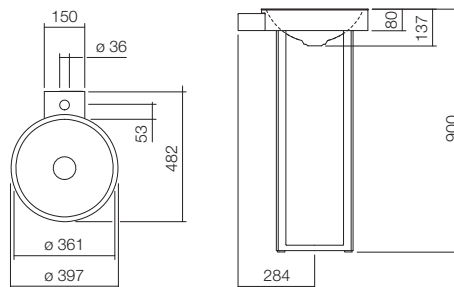
WT . RX400H . CR

Washstand, round, w/h/d 397/900/482 mm, sink round, centred, Ø 361 mm, sink depth 137 mm, glazed steel, white, with one tap hole, without overflow, steel bracket, powder finish, black matte, included fixing set, drain valve, valve cap, white glazed, Ø 84 mm, black matte wall bracket

	Art. No.
bicolor	4509 800 240

Recommended miscellaneous	Art. No.
Mirror, SP.300	6719 000 899
Mirror, SP.325	6716 000 899

Fittings information

Impact area approx. 143 – 178 mm from middle of tap hole.
For parameters, see page 20.

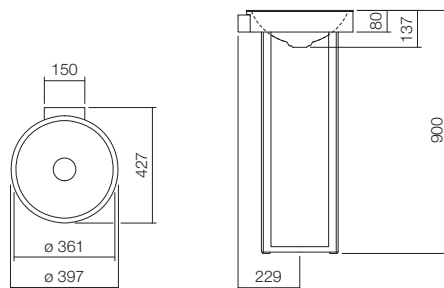
WT . RX400 . CR

Washstand, round, w/h/d 397/900/427 mm, sink round, centred, Ø 361 mm, sink depth 137 mm, glazed steel, white, without tap hole, without overflow, steel bracket, powder finish, black matte, included fixing set, drain valve, valve cap, white glazed, Ø 84 mm, black matte wall bracket

	Art. No.
bicolor	4509 500 240

Recommended miscellaneous	Art. No.
Mirror, SP.300	6719 000 899
Mirror, SP.325	6716 000 899

Fittings information

Impact area approx. 138 – 173 mm from rear edge of basin.
For parameters, see page 20.

Floor-standing washstands – CU-series – wall-mounted Mounting and connection measurements > see Page 186

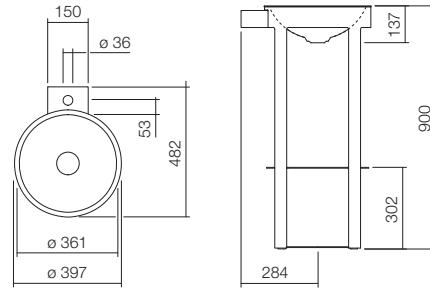
WT . RX400H . CU

Washstand, round, w/h/d 397/900/482 mm, sink round, centred, Ø 361 mm, sink depth 137 mm, glazed steel, with one tap hole, without overflow, steel bracket with shelf, powder finish, white, included fixing set, drain valve, valve cap, white glazed, Ø 84 mm, white wall bracket

	Art. No.
white, ProShield	4508 800 000

Recommended miscellaneous	Art. No.
Mirror, SP.300	6719 000 899
Mirror, SP.325	6716 000 899

Fittings information

Impact area approx. 143 – 178 mm from middle of tap hole.
For parameters, see page 20.

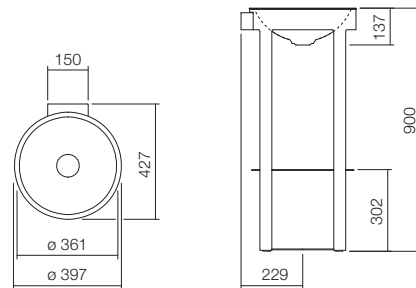
WT . RX400 . CU

Washstand, round, w/h/d 397/900/427 mm, sink round, centred, Ø 361 mm, sink depth 137 mm, glazed steel, without tap hole, without overflow, steel bracket with shelf, powder finish, white, included fixing set, drain valve, valve cap, white glazed, Ø 84 mm, white wall bracket

	Art. No.
white, ProShield	4508 500 000

Recommended miscellaneous	Art. No.
Mirror, SP.300	6719 000 899
Mirror, SP.325	6716 000 899

Fittings information

Impact area approx. 138 – 173 mm from rear edge of basin.
For parameters, see page 20.

Floor-standing washstands – K-series – wall-mounted

Mounting and connection measurements > see Page 186

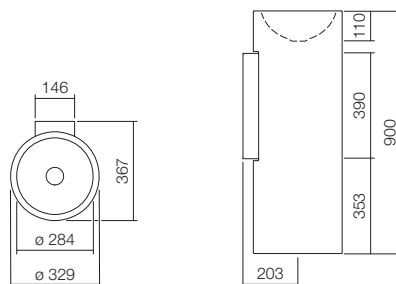
WT .RX325K

Washstand, round, w/h/d 329/900/367 mm, sink round, centred, $\varnothing 284$ mm, sink depth 110 mm, glazed steel, without tap hole, without overflow, included fixing set, drain valve, valve cap, chrome-plated, $\varnothing 63$ mm, bottle trap, white wall bracket

Art. No.

white, ProShield

4501 000 000

Version

Glossy, matt, special colour

Fittings information

Impact area approx. 125 – 155 mm from rear edge of basin.
For parameters, see page 20.

Recommended miscellaneous

Mirror, SP.300
Mirror, SP.325

Art. No.

6719 000 899
6716 000 899

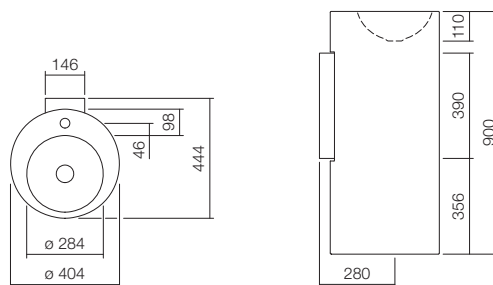
WT .RX400KH

Washstand, round, w/h/d 404/900/444 mm, sink round, centred, $\varnothing 284$ mm, sink depth 110 mm, glazed steel, with one tap hole, without overflow, included fixing set, drain valve, valve cap, chrome-plated, $\varnothing 63$ mm, bottle trap, white wall bracket

Art. No.

white, ProShield

4500 000 000

Version

Glossy, matt, special colour

Fittings information

Impact area approx. 110 – 140 mm from middle of tap hole.
For parameters, see page 20.

Recommended miscellaneous

Mirror, SP.300
Mirror, SP.325

Art. No.

6719 000 899
6716 000 899

Floor-standing washstands – K-series – wall-mounted

Mounting and connection measurements > see Page 186

WT .RX400K

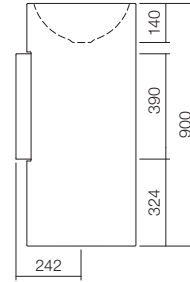
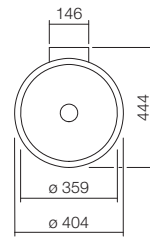

Washstand, round, w/h/d 404/900/444 mm, sink round, centred, Ø 359 mm, sink depth 140 mm, glazed steel, without tap hole, without overflow, included fixing set, drain valve, valve cap, chrome-plated, Ø 63 mm, bottle trap, white wall bracket

Art. No.

white, ProShield
dark iron > see chapter: Special glazes

4503 000 000

Version

Glossy, matt, special colour

Fittings information

Impact area approx. 152 – 192 mm from rear edge of basin.
For parameters, see page 20.

Recommended miscellaneous

Mirror, SP.300
Mirror, SP.325

Art. No.

6719 000 899
6716 000 899

Floor-standing washstands – CO-series – wall-mounted Mounting and connection measurements > see Page 187

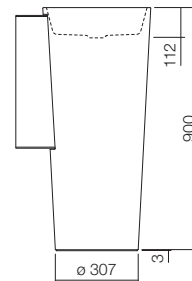
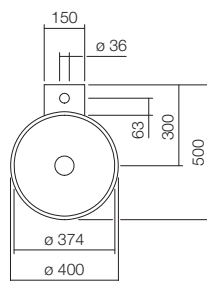
WT . RX400H . CO

Washstand, round, w/h/d 400/900/500 mm, sink round, centred, Ø 374 mm, sink depth 112 mm, glazed steel, with one tap hole, without overflow, included fixing set, drain valve, valve cap, white glazed, Ø 74 mm, bottle trap, white wall bracket

Art. No.

white, ProShield

4507 800 000

Version

Glossy, matt, special colour

Fittings information

Impact area approx. 163 – 198 mm from middle of tap hole.
For parameters, see page 20.

Recommended miscellaneous

Mirror, SP.300
Mirror, SP.325

Art. No.

6719 000 899
6716 000 899

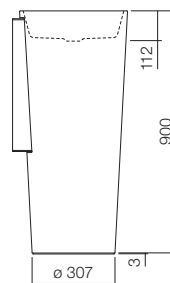
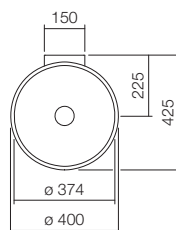
WT . RX400 . CO

Washstand, round, w/h/d 400/900/425 mm, sink round, centred, Ø 374 mm, sink depth 112 mm, glazed steel, without tap hole, without overflow, included fixing set, drain valve, valve cap, white glazed, Ø 74 mm, bottle trap, white wall bracket

Art. No.

white, ProShield

4507 500 000

Version

Glossy, matt, special colour

Fittings information

Impact area approx. 138 – 173 mm from rear edge of basin.
For parameters, see page 20.

Recommended miscellaneous

Mirror, SP.300
Mirror, SP.325

Art. No.

6719 000 899
6716 000 899

Floor-standing washstands – KE-series – wall-mounted

Mounting and connection measurements > see Page 186/187

WT . RX325 . KE

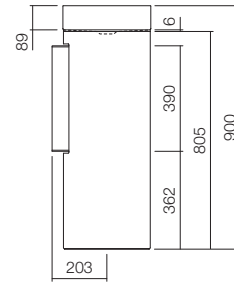
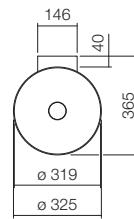

Washstand, round, w/h/d 325/900/365 mm, sink round, centred, Ø 319 mm, sink depth 89 mm, glazed steel, without tap hole, without overflow, included fixing set, drain valve, valve cap, chrome-plated, Ø 63 mm, bottle trap, chrome-plated spacer ring, white wall bracket

Art. No.

white, ProShield

4505 500 000

Version

Glossy, matt, special colour

Fittings information

Impact area approx. 125 – 160 mm from rear edge of basin.
For parameters, see page 20.

Recommended miscellaneous

Mirror, SP.300
Mirror, SP.325

Art. No.

6719 000 899
6716 000 899

WT . RX400 . KE

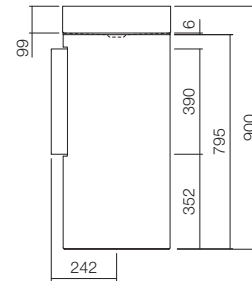
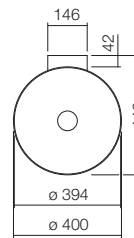

Washstand, round, w/h/d 400/900/442 mm, sink round, centred, Ø 394 mm, sink depth 99 mm, glazed steel, without tap hole, without overflow, included fixing set, drain valve, valve cap, chrome-plated, Ø 74 mm, bottle trap, chrome-plated spacer ring, white wall bracket

Art. No.

white, ProShield

bicolor > see chapter: Special glazes

4506 500 000

Version

Glossy, matt, special colour

Fittings information

Impact area approx. 147 – 192 mm from rear edge of basin.
For parameters, see page 20.

Recommended miscellaneous

Mirror, SP.300
Mirror, SP.325

Art. No.

6719 000 899
6716 000 899

Floor-standing washstands – Q-series – wall-mounted

Mounting and connection measurements > see Page 187

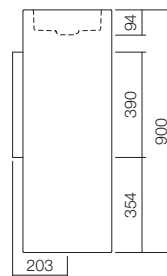
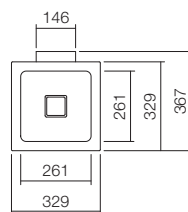
WT .RX325QS

Washstand, square, w/h/d 329/900/367 mm, sink square, centred, w/h/d 261/94/261 mm, glazed steel, without tap hole, without overflow, included fixing set, drain valve, valve cap, white glazed, w/d 68/68 mm, bottle trap, white wall bracket

Art. No.

white, ProShield

4801 000 000

Version

Glossy, matt, special colour

Fittings information

Impact area approx. 128 – 148 mm from rear edge of basin.
For parameters, see page 20.

Recommended miscellaneous

Mirror, SP.300
Mirror, SP.325

Art. No.

6719 000 899
6716 000 899

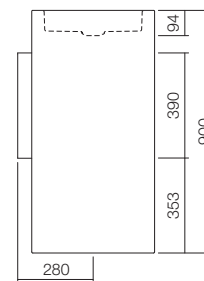
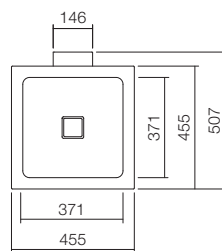
WT .RX450QS

Washstand, square, w/h/d 455/900/507 mm, sink square, centred, w/h/d 371/94/371 mm, glazed steel, without tap hole, without overflow, included fixing set, drain valve, valve cap, white glazed, w/d 68/68 mm, bottle trap, white wall bracket

Art. No.

white, ProShield

4804 000 000

Version

Glossy, matt, special colour

Fittings information

Impact area approx. 169 – 224 mm from rear edge of basin.
For parameters, see page 20.

Recommended miscellaneous

Mirror, SP.450

Art. No.

6717 000 899

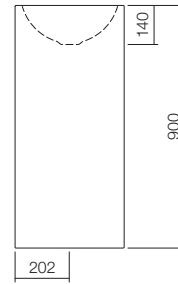
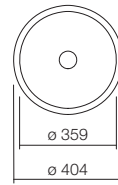
WT .RX400K

Washstand, round, w/h/d 404/900/404 mm, sink round, centred, Ø 359 mm, sink depth 140 mm, glazed steel, without tap hole, without overflow, included fixing set, drain valve, valve cap, chrome-plated, Ø 63 mm, bottle trap, floor bracket

Art. No.

white, ProShield

4504 000 000

Version

Glossy, matt, special colour

Fittings information

Impact area approx. 112 – 152 mm from rear edge of basin.
For parameters, see page 20.

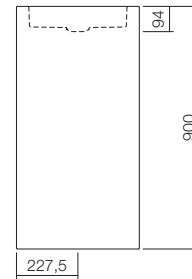
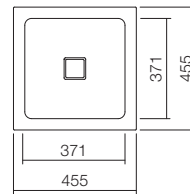
WT .RX450QS

Washstand, square, w/h/d 455/900/455 mm, sink square, centred, w/h/d 371/94/371 mm, glazed steel, without tap hole, without overflow, included fixing set, drain valve, valve cap, white glazed, w/d 68/68 mm, bottle trap, floor bracket

Art. No.

white, ProShield

4805 000 000

Version

Glossy, matt, special colour

Fittings information

Impact area approx. 117 – 172 mm from rear edge of basin.
For parameters, see page 20.

Washstands – RS-series

Mounting and connection measurements > see Page 187/188

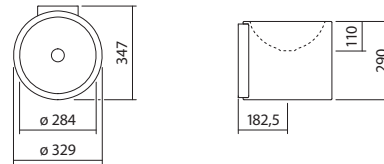
WT . RS325

Washstand, round, w/h/d 329/290/347 mm, sink round, centred, Ø 284 mm, sink depth 110 mm, glazed steel, without tap hole, without overflow, included fixing set, white wall bracket

Art. No.

white, ProShield

5041 000 000

Version

Glossy, matt, special colour

Fittings information

Impact area approx. 105 – 135 mm from rear edge of basin.
For parameters, see page 20.

Recommended miscellaneous

Bottle trap, Sl.2
Bottle trap, Sl.3
Drain valve, VT.2

Art. No.

8306 000 978
8312 000 978
8304 000 000

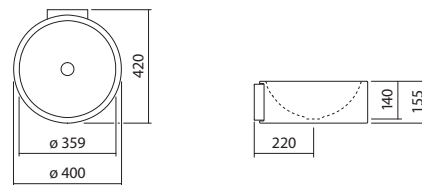
WT . RS400

Washstand, round, w/h/d 400/155/420 mm, sink round, centred, Ø 359 mm, sink depth 140 mm, glazed steel, without tap hole, without overflow, included fixing set, white wall bracket

Art. No.

white, ProShield

5052 000 000

Version

Glossy, matt, special colour

Fittings information

Impact area approx. 130 – 170 mm from rear edge of basin.
For parameters, see page 20.

Recommended miscellaneous

Bottle trap, Sl.2
Bottle trap, Sl.3
Drain valve, VT.3

Art. No.

8306 000 978
8312 000 978
8305 000 000

Washstands – RS-series

Mounting and connection measurements > see Page 187

WT . RS450

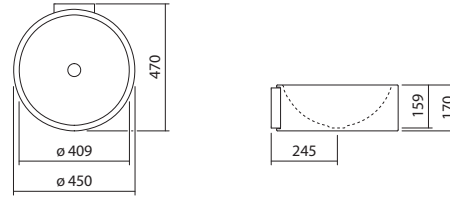

Washstand, round, w/h/d 450/170/470 mm, sink round, centred, Ø 409 mm, sink depth 159 mm, glazed steel, without tap hole, without overflow, included fixing set, white wall bracket

Art. No.

white, ProShield

5054 000 000

Version

Glossy, matt, special colour

Fittings information

Impact area approx. 130 – 190 mm from rear edge of basin.
For parameters, see page 20.

Recommended miscellaneous

Bottle trap, SI.2
Bottle trap, SI.3
Drain valve, VT.3

Art. No.

8306 000 978
8312 000 978
8305 000 000

Washstands – CO-series (Scopio)

Mounting and connection measurements > see Page 188

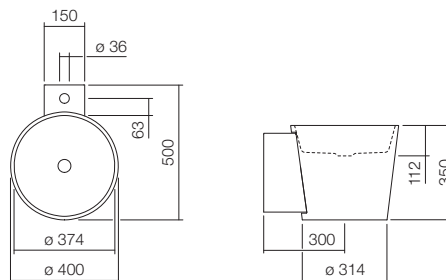
WT . C0400H

Washstand, round, w/h/d 400/350/500 mm, sink round, centred, $\varnothing 374$ mm, sink depth 112 mm, glazed steel, with one tap hole, without overflow, included fixing set, drain valve, valve cap, white glazed, $\varnothing 74$ mm, white wall bracket

Art. No.

white, ProShield

5042 800 000

Version

Glossy, matt, special colour

Fittings information

Impact area approx. 163 – 198 mm from middle of tap hole.
For parameters, see page 20.

Recommended miscellaneous

Bottle trap, Sl.2
Bottle trap, Sl.3

Art. No.

8306 000 978
8312 000 978

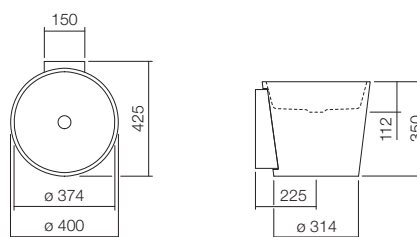
WT . C0400

Washstand, round, w/h/d 400/350/425 mm, sink round, centred, $\varnothing 374$ mm, sink depth 112 mm, glazed steel, without tap hole, without overflow, included fixing set, drain valve, valve cap, white glazed, $\varnothing 74$ mm, white wall bracket

Art. No.

white, ProShield

5042 500 000

Version

Glossy, matt, special colour

Fittings information

Impact area approx. 138 – 173 mm from rear edge of basin.
For parameters, see page 20.

Recommended miscellaneous

Bottle trap, Sl.2
Bottle trap, Sl.3

Art. No.

8306 000 978
8312 000 978

Washstands – IC-series

Mounting and connection measurements > see Page 188

WT . IC325H

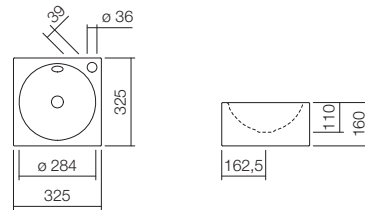

Washstand, square, w/h/d 325/160/325 mm, sink round, centred, Ø 284 mm, sink depth 110 mm, glazed steel, with one tap hole, with overflow, included fixing set, overflow set

	Art. No.	Version
white, ProShield	4236 200 000	Without overflow Glossy, matt, special colour

Fittings information	Recommended miscellaneous	Art. No.
Impact area approx. 104 – 134 mm from middle of tap hole. For parameters, see page 20.	Bottle trap, Sl.2 Bottle trap, Sl.3 Drain valve, VT.1 Angle valve cover, EV.3	8306 000 978 8312 000 978 8302 000 978 8110 000 978

WT . IC600H

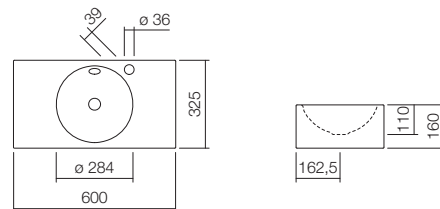

Washstand, rectangular, w/h/d 600/160/325 mm, sink round, centred, Ø 284 mm, sink depth 110 mm, glazed steel, with one tap hole, with overflow, included fixing set, overflow set

	Art. No.	Version
white, ProShield	4238 200 000	Without tap hole Without overflow Glossy, matt, special colour

Fittings information	Recommended miscellaneous	Art. No.
Impact area approx. 104 – 134 mm from middle of tap hole. For parameters, see page 20.	Bottle trap, Sl.2 Bottle trap, Sl.3 Drain valve, VT.1 Angle valve cover, EV.3	8306 000 978 8312 000 978 8302 000 978 8110 000 978

Washstands – IC-series

Mounting and connection measurements > see Page 188

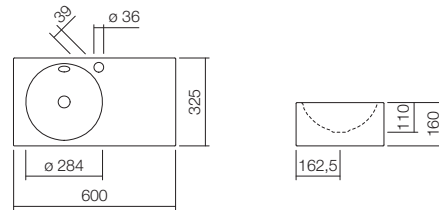
WT . IC600H . L

Washstand, rectangular, w/h/d 600/160/325 mm, sink round, left, Ø 284 mm, sink depth 110 mm, glazed steel, with one tap hole, with overflow, included fixing set, overflow set

Art. No.

white, ProShield

4239 200 000

Version

Without tap hole
Without overflow
Glossy, matt, special colour

Fittings information

Impact area approx. 104 – 134 mm from middle of tap hole.
For parameters, see page 20.

Recommended miscellaneous

Bottle trap, Sl.2
Bottle trap, Sl.3
Drain valve, VT.1
Angle valve cover, EV.3

Art. No.

8306 000 978
8312 000 978
8302 000 978
8110 000 978

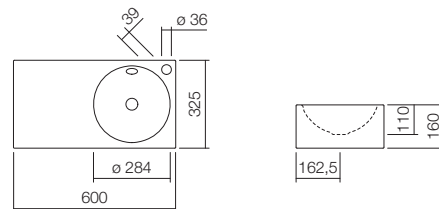
WT . IC600H . R

Washstand, rectangular, w/h/d 600/160/325 mm, sink round, right, Ø 284 mm, sink depth 110 mm, glazed steel, with one tap hole, with overflow, included fixing set, overflow set

Art. No.

white, ProShield

4240 200 000

Version

Without tap hole
Without overflow
Glossy, matt, special colour

Fittings information

Impact area approx. 104 – 134 mm from middle of tap hole.
For parameters, see page 20.

Recommended miscellaneous

Bottle trap, Sl.2
Bottle trap, Sl.3
Drain valve, VT.1
Angle valve cover, EV.3

Art. No.

8306 000 978
8312 000 978
8302 000 978
8110 000 978

Washstands – MC-series

Mounting and connection measurements > see Page 188/189

WT . MC450H



Washstand, rectangular, w/h/d 450/160/455 mm, sink round, centred, Ø 409 mm, sink depth 159 mm, glazed steel, with one tap hole, with overflow, included fixing set, overflow set

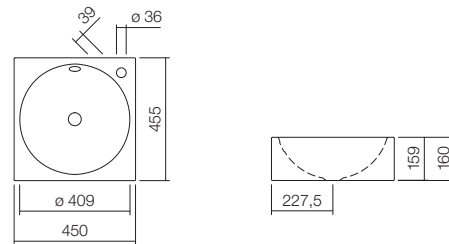

Art. No.
white, ProShield
4228 000 000

Version
Without overflow
Glossy, matt, special colour

Fittings information

Impact area approx. 129 – 189 mm from middle of tap hole.
For parameters, see page 20.

Recommended miscellaneous	Art. No.
Bottle trap, Sl.2	8306 000 978
Bottle trap, Sl.3	8312 000 978
Drain valve, VT.1	8302 000 978
Angle valve cover, EV.3	8110 000 978

WT . MC800H



Washstand, rectangular, w/h/d 800/160/455 mm, sink round, centred, Ø 409 mm, sink depth 159 mm, glazed steel, with one tap hole, with overflow, included fixing set, overflow set

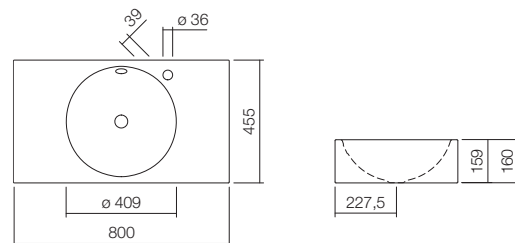

Art. No.
white, ProShield
4230 000 000

Version
Without overflow
Glossy, matt, special colour

Fittings information

Impact area approx. 129 – 189 mm from middle of tap hole.
For parameters, see page 20.

Recommended miscellaneous	Art. No.
Bottle trap, Sl.2	8306 000 978
Bottle trap, Sl.3	8312 000 978
Drain valve, VT.1	8302 000 978
Angle valve cover, EV.3	8110 000 978

Washstands – MC-series

WT . MC800H . L

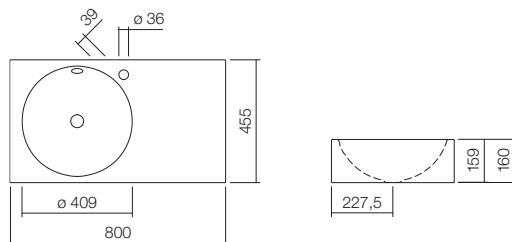

Washstand, rectangular, w/h/d 800/160/455 mm, sink round, left, Ø 409 mm, sink depth 159 mm, glazed steel, with one tap hole, with overflow, included fixing set, overflow set

	Art. No.
white, ProShield	4231 000 000

Version
Without tap hole
Without overflow
Glossy, matt, special colour

Fittings information
Impact area approx. 129 – 189 mm from middle of tap hole. For parameters, see page 20.

Recommended miscellaneous	Art. No.
Bottle trap, Sl.2	8306 000 978
Bottle trap, Sl.3	8312 000 978
Drain valve, VT.1	8302 000 978
Angle valve cover, EV.3	8110 000 978

WT . MC800H . R

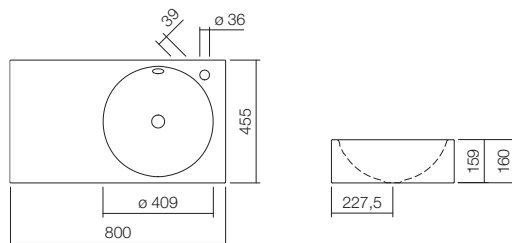

Washstand, rectangular, w/h/d 800/160/455 mm, sink round, right, Ø 409 mm, sink depth 159 mm, glazed steel, with one tap hole, with overflow, included fixing set, overflow set

	Art. No.
white, ProShield	4232 000 000

Version
Without tap hole
Without overflow
Glossy, matt, special colour

Fittings information
Impact area approx. 129 – 189 mm from middle of tap hole. For parameters, see page 20.

Recommended miscellaneous	Art. No.
Bottle trap, Sl.2	8306 000 978
Bottle trap, Sl.3	8312 000 978
Drain valve, VT.1	8302 000 978
Angle valve cover, EV.3	8110 000 978

Washstands – XXS-series (Fusion.S)

Mounting and connection measurements > see Page 189

WT . XXS450H . L

Price reduction

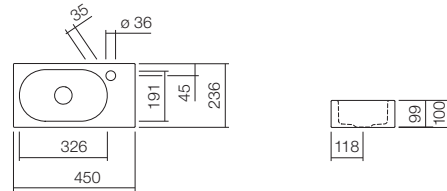

Washstand, rectangular, w/h/d 450/100/236 mm, sink oval, left, w/h/d 326/99/191 mm, glazed steel, with one tap hole, without overflow, included fixing set, drain valve, valve cap, chrome-plated, Ø 63 mm

Art. No.

white, ProShield

4295 000 000

Version

Glossy, matt, special colour

Fittings information

Impact area approx. 70 – 145 mm from middle of tap hole.
For parameters, see page 20.

Recommended miscellaneous

Bottle trap, Sl.2
Bottle trap, Sl.3
Angle valve cover, EV.3

Art. No.

8306 000 978
8312 000 978
8110 000 978

WT . XXS450 . L

Price reduction

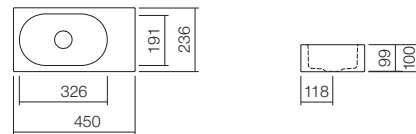

Washstand, rectangular, w/h/d 450/100/236 mm, sink oval, left, w/h/d 326/99/191 mm, glazed steel, without tap hole, without overflow, included fixing set, drain valve, valve cap, chrome-plated, Ø 63 mm

Art. No.

white, ProShield

4296 000 000

Version

Glossy, matt, special colour

Fittings information

Impact area approx. 60 – 75 mm from rear edge of basin.
For parameters, see page 20.

Recommended miscellaneous

Bottle trap, Sl.2
Bottle trap, Sl.3

Art. No.

8306 000 978
8312 000 978

Washstands – XXS-series (Fusion.S)

WT . XXS450H . R

Price reduction

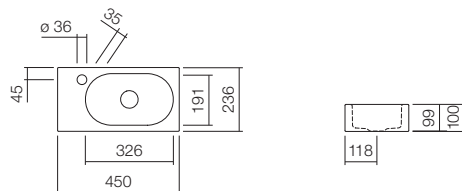

Washstand, rectangular, w/h/d 450/100/236 mm, sink oval, right, w/h/d 326/99/191 mm, glazed steel, with one tap hole, without overflow, included fixing set, drain valve, valve cap, chrome-plated, Ø 63 mm

Art. No.

white, ProShield

4297 000 000

Version

Glossy, matt, special colour

Fittings information

Impact area approx. 70 – 145 mm from middle of tap hole.
For parameters, see page 20.

Recommended miscellaneous

Bottle trap, Sl.2
Bottle trap, Sl.3
Angle valve cover, EV.3

Art. No.

8306 000 978
8312 000 978
8110 000 978

WT . XXS450 . R

Price reduction

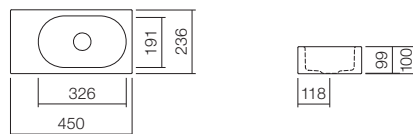

Washstand, rectangular, w/h/d 450/100/236 mm, sink oval, right, w/h/d 326/99/191 mm, glazed steel, without tap hole, without overflow, included fixing set, drain valve, valve cap, chrome-plated, Ø 63 mm

Art. No.

white, ProShield

4298 000 000

Version

Glossy, matt, special colour

Fittings information

Impact area approx. 60 – 75 mm from rear edge of basin.
For parameters, see page 20.

Recommended miscellaneous

Bottle trap, Sl.2
Bottle trap, Sl.3

Art. No.

8306 000 978
8312 000 978

Washstands – Q-series

Mounting and connection measurements > see Page 190

WT . QS325H

Price reduction

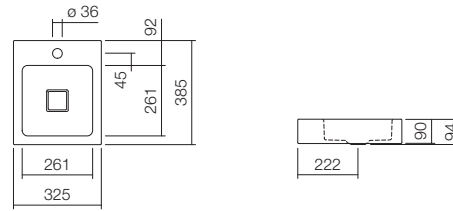

Washstand, rectangular, w/h/d 325/94/385 mm, sink square, centred, w/h/d 261/90/261 mm, glazed steel, with one tap hole, without overflow, included fixing set, drain valve, valve cap, white glazed, w/d 68/68 mm

	Art. No.
white, ProShield	4277 000 000

Version
Without tap hole
3 Drill holes
Drill hole for lotion dispenser
Glossy, matt, special colour

Fittings information
Impact area approx. 100 – 120 mm from middle of tap hole.
For parameters, see page 20.

Recommended miscellaneous	Art. No.
Bottle trap, Sl.2	8306 000 978
Bottle trap, Sl.3	8312 000 978
Angle valve cover, EV.3	8110 000 978

WT . QS325

Price reduction

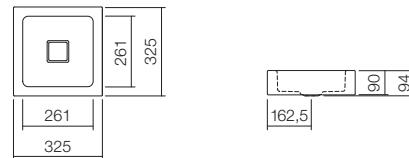

Washstand, square, w/h/d 325/94/325 mm, sink square, centred, w/h/d 261/90/261 mm, glazed steel, without tap hole, without overflow, included fixing set, drain valve, valve cap, white glazed, w/d 68/68 mm

	Art. No.
white, ProShield	4270 000 000

Version
Glossy, matt, special colour

Fittings information
Impact area approx. 88 – 108 mm from rear edge of basin.
For parameters, see page 20.

Recommended miscellaneous	Art. No.
Bottle trap, Sl.2	8306 000 978
Bottle trap, Sl.3	8312 000 978

Washstands – Q-series

Mounting and connection measurements > see Page 190

WT . QS325X

Price reduction

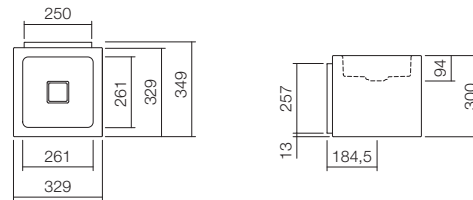

Washstand, square, w/h/d 329/300/349 mm, sink square, centred, w/h/d 261/94/261 mm, glazed steel, without tap hole, without overflow, included fixing set, drain valve, valve cap, white glazed, w/d 68/68 mm

Art. No.

white, ProShield

4271 000 000

Version

Glossy, matt, special colour

Fittings information

Impact area approx. 110 – 130 mm from rear edge of basin.
For parameters, see page 20.

Recommended miscellaneous

Bottle trap, Sl.2
Bottle trap, Sl.3

Art. No.

8306 000 978
8312 000 978

WT . QS525H . L

Price reduction

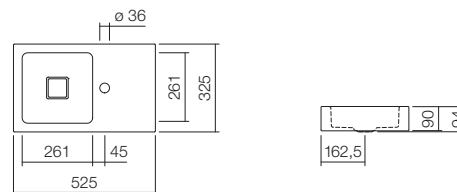

Washstand, rectangular, w/h/d 525/94/325 mm, sink square, left, w/h/d 261/90/261 mm, glazed steel, with one tap hole, without overflow, included fixing set, drain valve, valve cap, white glazed, w/d 68/68 mm

Art. No.

white, ProShield

4279 000 000

Version

Glossy, matt, special colour

Fittings information

Impact area approx. 100 – 120 mm from middle of tap hole.
For parameters, see page 20.

Recommended miscellaneous

Bottle trap, Sl.2
Bottle trap, Sl.3
Angle valve cover, EV.3

Art. No.

8306 000 978
8312 000 978
8110 000 978

Washstands – Q-series

Mounting and connection measurements > see Page 190

WT . QS525 . L

Price reduction



Washstand, rectangular, w/h/d 525/94/325 mm, sink square, left, w/h/d 261/90/261 mm, glazed steel, without tap hole, without overflow, included fixing set, drain valve, valve cap, white glazed, w/d 68/68 mm

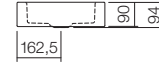
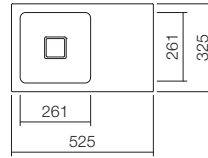

Art. No.
white, ProShield 4273 000 000

Version
Glossy, matt, special colour

Fittings information

Impact area approx. 88 – 108 mm from rear edge of basin.
For parameters, see page 20.

Recommended miscellaneous

Recommended miscellaneous	Art. No.
Bottle trap, Sl.2	8306 000 978
Bottle trap, Sl.3	8312 000 978

WT . QS525H . R

Price reduction



Washstand, rectangular, w/h/d 525/94/325 mm, sink square, right, w/h/d 261/90/261 mm, glazed steel, with one tap hole, without overflow, included fixing set, drain valve, valve cap, white glazed, w/d 68/68 mm

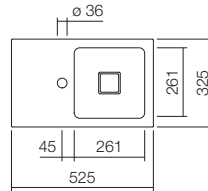

Art. No.
white, ProShield 4280 000 000

Version
Glossy, matt, special colour

Fittings information

Impact area approx. 100 – 120 mm from middle of tap hole.
For parameters, see page 20.

Recommended miscellaneous

Recommended miscellaneous	Art. No.
Bottle trap, Sl.2	8306 000 978
Bottle trap, Sl.3	8312 000 978
Angle valve cover, EV.3	8110 000 978

Washstands – Q-series

Mounting and connection measurements > see Page 190

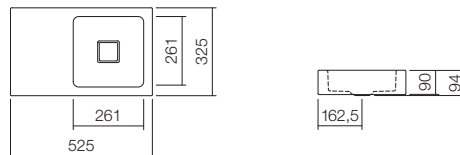
WT . QS525 . R**Price reduction**

Washstand, rectangular, w/h/d 525/94/325 mm, sink square, right, w/h/d 261/90/261 mm, glazed steel, without tap hole, without overflow, included fixing set, drain valve, valve cap, white glazed, w/d 68/68 mm

Art. No.

white, ProShield

4274 000 000

Version

Glossy, matt, special colour

Fittings information

Impact area approx. 88 – 108 mm from rear edge of basin.
For parameters, see page 20.

Recommended miscellaneous

Bottle trap, Sl.2
Bottle trap, Sl.3

Art. No.

8306 000 978
8312 000 978

Washstands – XS-series (X.plore.S)

Mounting and connection measurements > see Page 189/190

WT . XS500H . L

Price reduction



Washstand, rectangular, w/h/d 500/100/268 mm, sink rectangular, left, w/h/d 345/95/215 mm, glazed steel, with one tap hole, without overflow, included fixing set, drain valve, valve cap, white glazed, w/d 68/68 mm

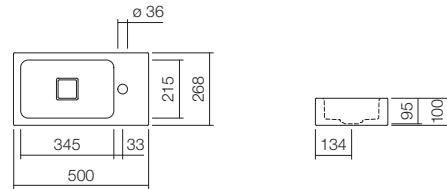

Art. No.
white, ProShield
4290 000 000

Version
Glossy, matt, special colour

Fittings information

Impact area approx. 110 – 205 mm from middle of tap hole.
For parameters, see page 20.

Recommended miscellaneous	Art. No.
Bottle trap, Sl.2	8306 000 978
Bottle trap, Sl.3	8312 000 978
Angle valve cover, EV.3	8110 000 978

WT . XS500 . L

Price reduction



Washstand, rectangular, w/h/d 500/100/268 mm, sink rectangular, left, w/h/d 345/95/215 mm, glazed steel, without tap hole, without overflow, included fixing set, drain valve, valve cap, white glazed, w/d 68/68 mm

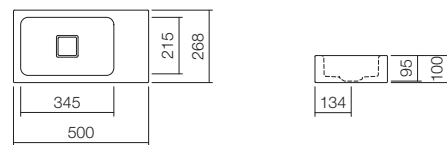

Art. No.
white, ProShield
4291 000 000

Version
Glossy, matt, special colour

Fittings information

Impact area approx. 75 – 135 mm from rear edge of basin.
For parameters, see page 20.

Recommended miscellaneous	Art. No.
Bottle trap, Sl.2	8306 000 978
Bottle trap, Sl.3	8312 000 978

Washstands – XS-series (X.plore.S)

Mounting and connection measurements > see Page 190

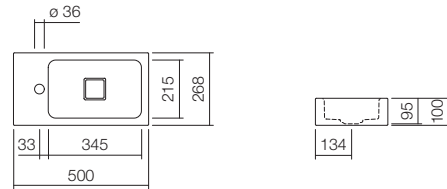
WT . XS500H . R**Price reduction**

Washstand, rectangular, w/h/d 500/100/268 mm, sink rectangular, right, w/h/d 345/95/215 mm, glazed steel, with one tap hole, without overflow, included fixing set, drain valve, valve cap, white glazed, w/d 68/68 mm

Art. No.

white, ProShield

4292 000 000

Version

Glossy, matt, special colour

Fittings information

Impact area approx. 110 – 205 mm from middle of tap hole.
For parameters, see page 20.

Recommended miscellaneous**Art. No.**

Bottle trap, Sl.2
Bottle trap, Sl.3
Angle valve cover, EV.3

8306 000 978
8312 000 978
8110 000 978

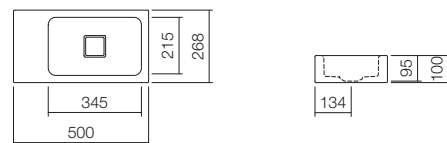
WT . XS500 . R**Price reduction**

Washstand, rectangular, w/h/d 500/100/268 mm, sink rectangular, right, w/h/d 345/95/215 mm, glazed steel, without tap hole, without overflow, included fixing set, drain valve, valve cap, white glazed, w/d 68/68 mm

Art. No.

white, ProShield

4293 000 000

Version

Glossy, matt, special colour

Fittings information

Impact area approx. 75 – 135 mm from rear edge of basin.
For parameters, see page 20.

Recommended miscellaneous**Art. No.**

Bottle trap, Sl.2
Bottle trap, Sl.3

8306 000 978
8312 000 978

Washstands – SR-series (Stream)

Mounting and connection measurements > see Page 191

WT . SR800H . L



Washstand, rectangular, w/h/d 800/127/472 mm, sink rectangular, left, w/h/d 609/100/359 mm, glazed steel, with one tap hole, with overflow, included fixing set, overflow set

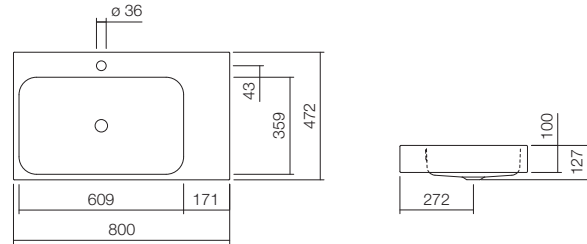

	Art. No.
white, ProShield	4281 600 000

Fittings information

Impact area approx. 105 – 155 mm from middle of tap hole.
For parameters, see page 20.

Version	Art. No.
Without tap hole	
Without overflow	
3 Drill holes	
Drill hole for lotion dispenser	
Glossy, matt, special colour	

Recommended miscellaneous	Art. No.
Bottle trap, Sl.2	8306 000 978
Bottle trap, Sl.3	8312 000 978
Drain valve, VT.1	8302 000 978
Angle valve cover, EV.3	8110 000 978

WT . SR800H . R



Washstand, rectangular, w/h/d 800/127/472 mm, sink rectangular, right, w/h/d 609/100/359 mm, glazed steel, with one tap hole, with overflow, included fixing set, overflow set

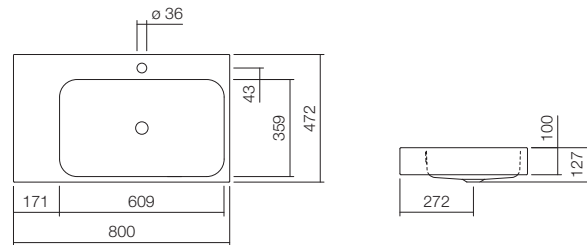

	Art. No.
white, ProShield	4282 600 000

Fittings information

Impact area approx. 105 – 155 mm from middle of tap hole.
For parameters, see page 20.

Version	Art. No.
Without tap hole	
Without overflow	
3 Drill holes	
Drill hole for lotion dispenser	
Glossy, matt, special colour	

Recommended miscellaneous	Art. No.
Bottle trap, Sl.2	8306 000 978
Bottle trap, Sl.3	8312 000 978
Drain valve, VT.1	8302 000 978
Angle valve cover, EV.3	8110 000 978

Washstands – PR-series

Mounting and connection measurements > see Page 191

WT . PR585H

Price reduction

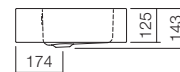
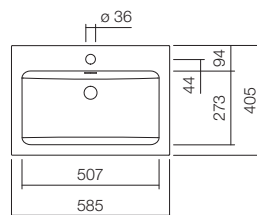

Washstand, rectangular, w/h/d 585/143/405 mm, sink rectangular, centred, w/h/d 507/125/273 mm, glazed steel, with one tap hole, with overflow, included fixing set, overflow set

Art. No.

white, ProShield

4201 000 000

Version

Without tap hole
Without overflow
3 Drill holes
Drill hole for lotion dispenser
Glossy, matt, special colour

Fittings information

Impact area approx. 168 – 188 mm from middle of tap hole.
For parameters, see page 20.

Recommended miscellaneous

Art. No.

Bottle trap, Sl.2	8306 000 978
Bottle trap, Sl.3	8312 000 978
Drain valve, VT.1	8302 000 978
Angle valve cover, EV.3	8110 000 978

WT . PR585

Price reduction

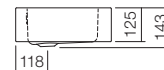
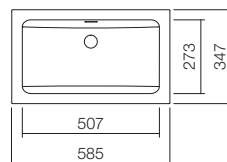

Washstand, rectangular, w/h/d 585/143/347 mm, sink rectangular, centred, w/h/d 507/125/273 mm, glazed steel, without tap hole, with overflow, included fixing set, overflow set

Art. No.

white, ProShield

4200 000 000

Version

Without overflow
Glossy, matt, special colour

Fittings information

Impact area approx. 162 – 182 mm from rear edge of basin.
For parameters, see page 20.

Recommended miscellaneous

Art. No.

Bottle trap, Sl.2	8306 000 978
Bottle trap, Sl.3	8312 000 978
Drain valve, VT.1	8302 000 978

Washstands – PR-series

Mounting and connection measurements > see Page 191

WT . PR800H

Price reduction



Washstand, rectangular, w/h/d 800/143/405 mm, sink rectangular, centred, w/h/d 507/125/273 mm, glazed steel, with one tap hole, with overflow, included fixing set, overflow set

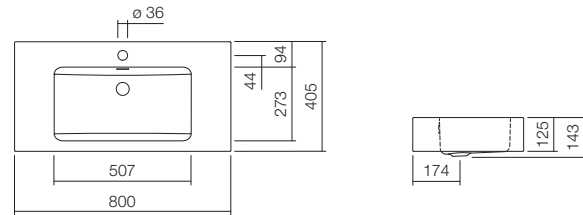

	Art. No.
white, ProShield	4203 000 000

Fittings information

Impact area approx. 168 – 188 mm from middle of tap hole.
For parameters, see page 20.

Version	
Without overflow	
3 Drill holes	
Drill hole for lotion dispenser	
Glossy, matt, special colour	

Recommended miscellaneous	Art. No.
Bottle trap, Sl.2	8306 000 978
Bottle trap, Sl.3	8312 000 978
Drain valve, VT.1	8302 000 978
Angle valve cover, EV.3	8110 000 978

WT . PR800

Price reduction



Washstand, rectangular, w/h/d 800/143/405 mm, sink rectangular, centred, w/h/d 507/125/273 mm, glazed steel, without tap hole, with overflow, included fixing set, overflow set

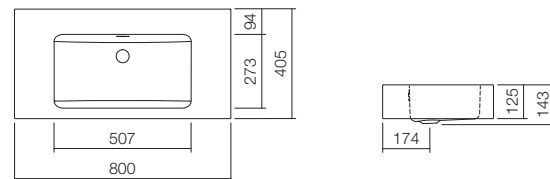

	Art. No.
white, ProShield	4203 300 000

Fittings information

Impact area approx. 218 – 238 mm from rear edge of basin.
For parameters, see page 20.

Version	
Without overflow	
3 Drill holes	
Drill hole for lotion dispenser	
Glossy, matt, special colour	

Recommended miscellaneous	Art. No.
Bottle trap, Sl.2	8306 000 978
Bottle trap, Sl.3	8312 000 978
Drain valve, VT.1	8302 000 978

Washstands – PR-series

Mounting and connection measurements > see Page 191/192

WT . PR800H . L**Price reduction**

Washstand, rectangular, w/h/d 800/143/405 mm, sink rectangular, left, w/h/d 507/125/273 mm, glazed steel, with one tap hole, with overflow, included fixing set, overflow set

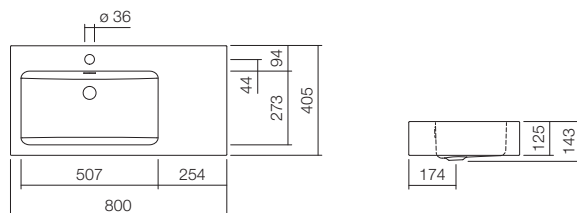

	Art. No.
white, ProShield	4205 000 000

Version
Without overflow
3 Drill holes
Drill hole for lotion dispenser
Glossy, matt, special colour

Fittings information

Impact area approx. 168 – 188 mm from middle of tap hole.
For parameters, see page 20.

Recommended miscellaneous	Art. No.
Bottle trap, Sl.2	8306 000 978
Bottle trap, Sl.3	8312 000 978
Drain valve, VT.1	8302 000 978
Angle valve cover, EV.3	8110 000 978

WT . PR800 . L**Price reduction**

Washstand, rectangular, w/h/d 800/143/405 mm, sink rectangular, left, w/h/d 507/125/273 mm, glazed steel, without tap hole, with overflow, included fixing set, overflow set

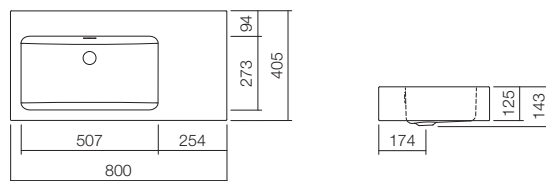

	Art. No.
white, ProShield	4205 300 000

Version
Without overflow
3 Drill holes
Drill hole for lotion dispenser
Glossy, matt, special colour

Fittings information

Impact area approx. 218 – 238 mm from rear edge of basin.
For parameters, see page 20.

Recommended miscellaneous	Art. No.
Bottle trap, Sl.2	8306 000 978
Bottle trap, Sl.3	8312 000 978
Drain valve, VT.1	8302 000 978

Washstands – PR-series

Mounting and connection measurements > see Page 191/192

WT . PR800H . R

Price reduction



Washstand, rectangular, w/h/d 800/143/405 mm, sink rectangular, right, w/h/d 507/125/273 mm, glazed steel, with one tap hole, with overflow, included fixing set, overflow set

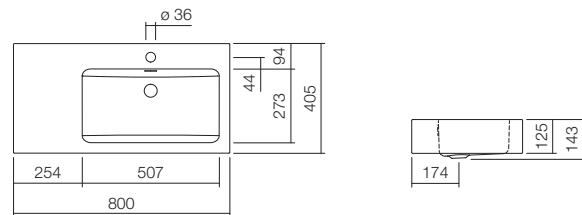

	Art. No.
white, ProShield	4207 000 000

Version
Without overflow
3 Drill holes
Drill hole for lotion dispenser
Glossy, matt, special colour

Fittings information

Impact area approx. 168 – 188 mm from middle of tap hole.
For parameters, see page 20.

Recommended miscellaneous	Art. No.
Bottle trap, Sl.2	8306 000 978
Bottle trap, Sl.3	8312 000 978
Drain valve, VT.1	8302 000 978
Angle valve cover, EV.3	8110 000 978

WT . PR800 . R

Price reduction



Washstand, rectangular, w/h/d 800/143/405 mm, sink rectangular, right, w/h/d 507/125/273 mm, glazed steel, without tap hole, with overflow, included fixing set, overflow set

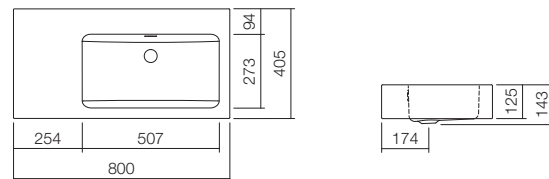

	Art. No.
white, ProShield	4207 300 000

Version
Without overflow
3 Drill holes
Drill hole for lotion dispenser
Glossy, matt, special colour

Fittings information

Impact area approx. 218 – 238 mm from rear edge of basin.
For parameters, see page 20.













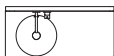

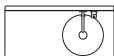
Recommended miscellaneous	Art. No.
Bottle trap, Sl.2	8306 000 978
Bottle trap, Sl.3	8312 000 978
Drain valve, VT.1	8302 000 978

Washplaces made from glazed steel

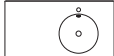
WP

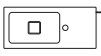
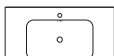

Xplore.S
Washplace
WP . XS2
645 x 300 x 268mm

Width of washplace				
below 300mm	350 – 580mm	600 – 700mm	1000mm	
	 <p>WP.Insert1 485 x 321mm Page 130</p>	 <p>WP.S19.1/.1R 600 x 360mm Page 136</p>	 <p>WP.S19L.1/.1R 1000 x 490mm Page 137</p>	Round, wall-mounted
	 <p>WP.Insert2 485 x 321mm Page 130</p>		 <p>WP.S19L.2/.2R 1000 x 490mm Page 138</p>	
	 <p>WP.Insert5 355 x 350mm Page 131</p>		 <p>WP.WF20.1 1000 x 525mm Page 139</p>	
	 <p>WP.PN1/SET.WP.PN1 555 x 320mm Page 132/133</p>		 <p>WP.WF20.2 1000 x 525mm Page 139</p>	
	 <p>WP.PN2/SET.WP.PN2 555 x 320mm Page 132/133</p>		 <p>WP.WF20.3 1000 x 525mm Page 140</p>	
			 <p>WP.WF20.4 1000 x 525mm Page 140</p>	
	 <p>WP.XXS1 580 x 236mm Page 134</p>	 <p>WP.XS1 645 x 268mm Page 135</p>	 <p>WP.WF100.1 1000 x 525mm Page 141</p>	Rectangular
	 <p>WP.XXS2 580 x 236mm Page 134</p>	 <p>WP.XS2 645 x 268mm Page 135</p>		

Washplaces – Insert-series

Mounting and connection measurements > see Page 192

WP . INSERT1

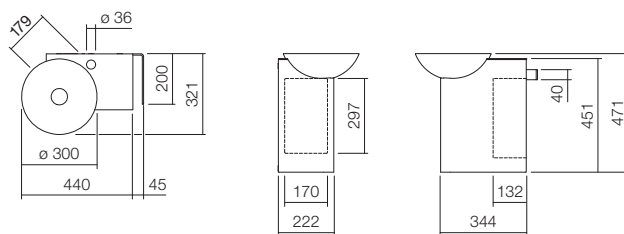

Washplace, rectangular, w/h/d 485/471/321 mm, dish basin, ProShield, sink left, with one tap hole, without overflow, shelf cabinet right, frame, chrome steel, powder finish, white, towel rail right, white, fixing set, drain valve, valve cap, chrome-plated, Ø 63 mm, bottle trap

	Art. No.
white glazed steel shelf	5241 000 000
anthracite brown glazed steel shelf	5241 000 110

Recommended miscellaneous	Art. No.
Mirror, SP.300	6719 000 899

Fittings information

Impact area approx. 109 – 139 mm from middle of tap hole.
For parameters, see page 20.

WP . INSERT2

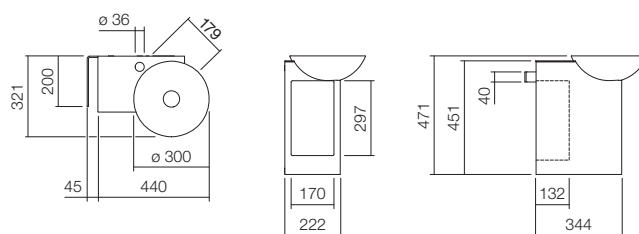

Washplace, rectangular, w/h/d 485/471/321 mm, dish basin, ProShield, sink right, with one tap hole, without overflow, shelf cabinet left, frame, chrome steel, powder finish, white, towel rail left, white, fixing set, drain valve, valve cap, chrome-plated, Ø 63 mm, bottle trap

	Art. No.
white glazed steel shelf	5242 000 000
anthracite brown glazed steel shelf	5242 000 110

Recommended miscellaneous	Art. No.
Mirror, SP.300	6719 000 899

Fittings information

Impact area approx. 109 – 139 mm from middle of tap hole.
For parameters, see page 20.

Washplaces – Insert-series

Mounting and connection measurements > see Page 192

WP . INSERT5

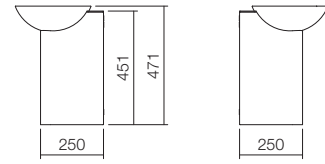
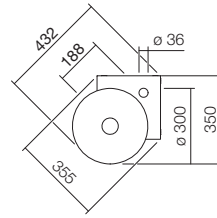

Corner washplace, rectangular, w/h/d 355/471/350 mm, dish basin, ProShield, sink centred, with one tap hole, without overflow, frame, chrome steel, powder finish, white, fixing set, drain valve, valve cap, chrome-plated, Ø 63 mm, bottle trap

	Art. No.
white glazed steel shelf	5245 000 000
anthracite brown glazed steel shelf	5245 000 110

Recommended miscellaneous	Art. No.
Corner mirror, SP.300C	6720 000 899

Fittings information

Impact area approx. 117 – 147 mm from middle of tap hole.
For parameters, see page 20.

Washplaces – PN-series (Piccolo Novo)

Mounting and connection measurements > see Page 192

WP . PN1

Washplace, rectangular, w/h/d 555/400/320 mm, dish basin, sink left, Ø 300 mm, sink depth 112 mm, glazed steel, ProShield, with one tap hole, without overflow, steel, glazed, polished stainless steel, included fixing set, drain valve, valve cap, glazed in the basin colour, Ø 84 mm, chrome-plated bottle trap

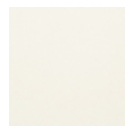
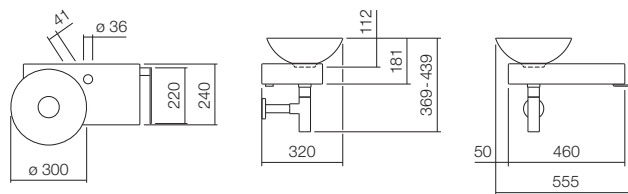

white



nordic matt



oyster matt



gravel matt

	Art. No.
white	5256 000 000
nordic matt	5256 000 083
oyster matt	5256 000 081
gravel matt	5256 000 084

Recommended miscellaneous

Mirror, SP.300
Design mirror, SP.FR375.S1

Art. No.

6719 000 899
6740 001 899

Fittings information

Impact area approx. 121 – 151 mm from middle of tap hole.
For parameters, see page 20.

WP . PN2

Washplace, rectangular, w/h/d 555/400/320 mm, dish basin, sink right, Ø 300 mm, sink depth 112 mm, glazed steel, ProShield, with one tap hole, without overflow, steel, glazed, polished stainless steel, included fixing set, drain valve, valve cap, glazed in the basin colour, Ø 84 mm, chrome-plated bottle trap

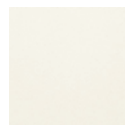
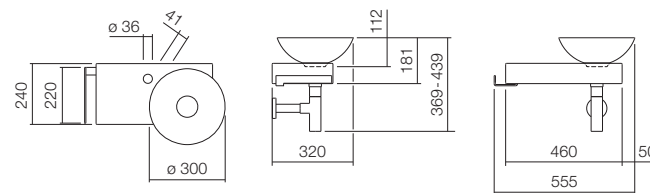

white



nordic matt



oyster matt



gravel matt

	Art. No.
white	5257 000 000
nordic matt	5257 000 083
oyster matt	5257 000 081
gravel matt	5257 000 084

Recommended miscellaneous

Mirror, SP.300
Design mirror, SP.FR375.S1

Art. No.

6719 000 899
6740 001 899

Fittings information

Impact area approx. 121 – 151 mm from middle of tap hole.
For parameters, see page 20.

Washplaces – PN-series (Piccolo Novo)

Mounting and connection measurements > see Page 192

SET . WP . PN1



Washplace, rectangular, w/h/d 555/597/320 mm, dish basin, sink left, Ø 300 mm, sink depth 112 mm, glazed steel, ProShield, with one tap hole, without overflow, steel, glazed, polished stainless steel, included fixing set, drain valve, valve cap, glazed in the basin colour, Ø 84 mm, chrome-plated bottle trap, single-lever basin mixer with raised base

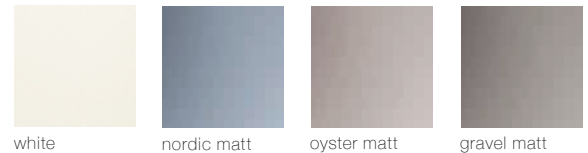
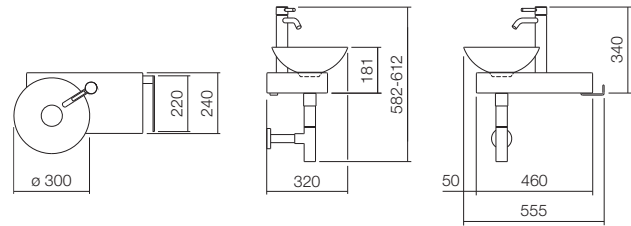

	Art. No.
white	0613 001 000
nordic matt	0613 001 083
oyster matt	0613 001 081
gravel matt	0613 001 084

Recommended miscellaneous

Mirror, SP.300
Design mirror, SP.FR375.S1

Art. No.

6719 000 899
6740 001 899

Fittings information

Impact area approx. 121 – 151 mm from middle of tap hole.
For parameters, see page 20.

SET . WP . PN2



Washplace, rectangular, w/h/d 555/597/320 mm, dish basin, sink right, Ø 300 mm, sink depth 112 mm, glazed steel, ProShield, with one tap hole, without overflow, steel, glazed, polished stainless steel, included fixing set, drain valve, valve cap, glazed in the basin colour, Ø 84 mm, chrome-plated bottle trap, single-lever basin mixer with raised base

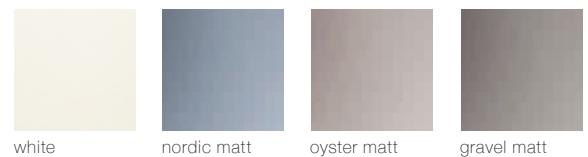
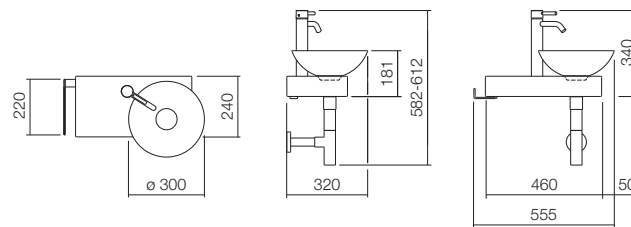

	Art. No.
white	0613 002 000
nordic matt	0613 002 083
oyster matt	0613 002 081
gravel matt	0613 002 084

Recommended miscellaneous

Mirror, SP.300
Design mirror, SP.FR375.S1

Art. No.

6719 000 899
6740 001 899

Fittings information

Impact area approx. 121 – 151 mm from middle of tap hole.
For parameters, see page 20.

Washplaces – XXS-series (Fusion.S)

Mounting and connection measurements > see Page 193

WP . XXS1**Price reduction**

Washplace, rectangular, w/h/d 580/240/236 mm, sink oval, left, glazed steel, with one tap hole, without overflow, shelf cabinet right, furniture surface, chipboard, decoration, glossy white, towel rail right, white, fixing set, drain valve, valve cap, chrome-plated, Ø 63 mm

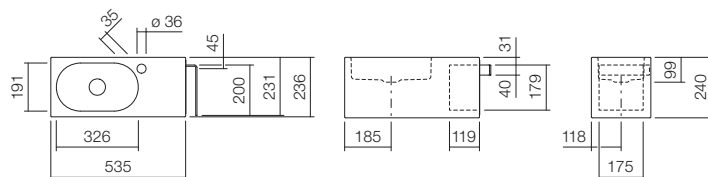
**Art. No.**

white, ProShield

5062 800 000

Recommended miscellaneous

Mirror, SP.300

Art. No.

6719 000 899

Fittings information

Impact area approx. 70 – 145 mm from middle of tap hole.
For parameters, see page 20.

WP . XXS2**Price reduction**

Washplace, rectangular, w/h/d 580/240/236 mm, sink oval, right, glazed steel, with one tap hole, without overflow, shelf cabinet left, furniture surface, chipboard, decoration, glossy white, towel rail left, white, fixing set, drain valve, valve cap, chrome-plated, Ø 63 mm

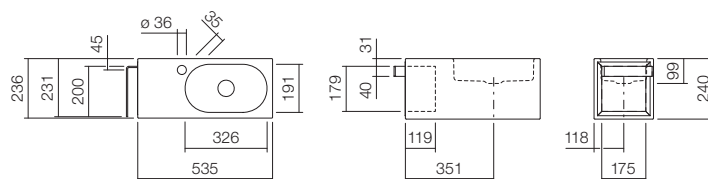
**Art. No.**

white, ProShield

5065 800 000

Recommended miscellaneous

Mirror, SP.300

Art. No.

6719 000 899

Fittings information

Impact area approx. 70 – 145 mm from middle of tap hole.
For parameters, see page 20.

Washplaces – XS-series (X.plore.S)

Mounting and connection measurements > see Page 193

WP . XS1

Price reduction

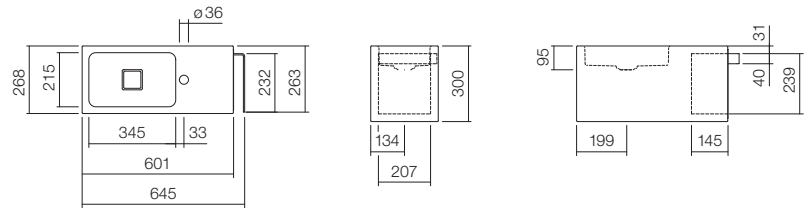

Washplace, rectangular, w/h/d 645/300/268 mm, sink rectangular, left, glazed steel, with one tap hole, without overflow, shelf cabinet right, furniture surface, chipboard, decoration, white, towel rail right, white, fixing set, drain valve, valve cap, white glazed, w/d 68/68 mm

white, ProShield **Art. No.** 5072 800 000

Recommended miscellaneous **Art. No.** Mirror, SP.325 6716 000 899

Fittings information

Impact area approx. 110 – 205 mm from middle of tap hole.
For parameters, see page 20.

WP . XS2

Price reduction

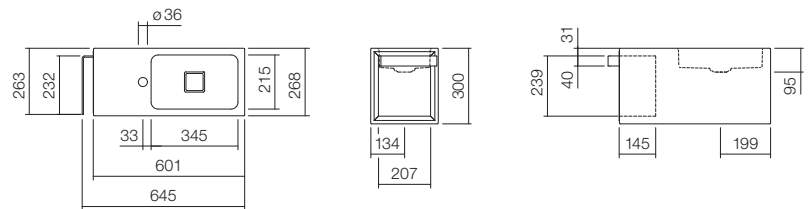

Washplace, rectangular, w/h/d 645/300/268 mm, sink rectangular, right, glazed steel, with one tap hole, without overflow, shelf cabinet left, furniture surface, chipboard, decoration, white, towel rail left, white, fixing set, drain valve, valve cap, white glazed, w/d 68/68 mm

white, ProShield **Art. No.** 5075 800 000

Recommended miscellaneous **Art. No.** Mirror, SP.325 6716 000 899

Fittings information

Impact area approx. 110 – 205 mm from middle of tap hole.
For parameters, see page 20.

Washplaces – S19-series (Steel19)

Mounting and connection measurements > see Page 194

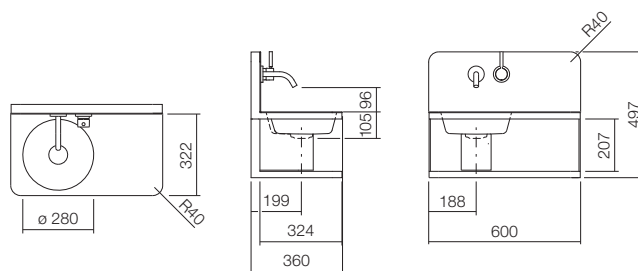
WP . S19 . 1**Price reduction**

Washplace, rectangular, w/h/d 600/497/360 mm, sink round, left, glazed steel, without overflow, bracket, steel bracket, powder finish, black matte, included fixing set, drain valve, valve cap, glazed in the basin colour, $\varnothing 74$ mm, bottle trap, bottle trap cover in matt black, glass shelf, wall outlet fitting in splashback, with pre-assembled concealed valve

Art. No.

white, ProShield

5260 000 000

Recommended miscellaneous

Design mirror, SP.FR600.R1
Shelf, AS.400.S
Shelf, AS.600.S
Perforated block, AS.Box1
Box, AS.Box2

Art. No.

6744 001 899
8270 000 980
8271 000 980
8266 000 671
8267 000 671

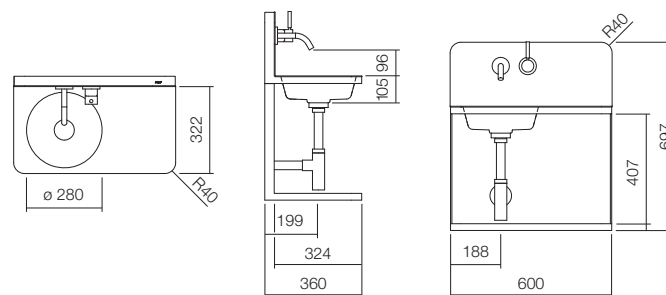
WP . S19 . 1R**Price reduction**

Washplace for renovation, rectangular, w/h/d 600/697/360 mm, sink round, left, glazed steel, without overflow, bracket, steel bracket, powder finish, black matte, pressure hoses 600mm, included fixing set, drain valve, valve cap, glazed in the basin colour, $\varnothing 74$ mm, bottle trap, glass shelf, wall outlet fitting in splashback, with pre-assembled concealed valve

Art. No.

white, ProShield

5266 000 000

Recommended miscellaneous

Design mirror, SP.FR600.R1
Shelf, AS.400.S
Shelf, AS.600.S
Perforated block, AS.Box1
Box, AS.Box2

Art. No.

6744 001 899
8270 000 980
8271 000 980
8266 000 671
8267 000 671

Washplaces – S19-series (Steel19)

Mounting and connection measurements > see Page 194

WP . S19L . 1

Price reduction

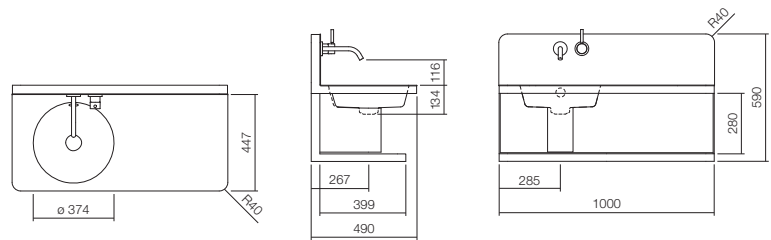

Washplace, rectangular, w/h/d 1000/590/490 mm, sink round, left, glazed steel, with overflow, bracket, steel bracket, powder finish, black matte, included fixing set, valve cap, glazed in the basin colour, Ø 74 mm, bottle trap, bottle trap cover in matt black, glass shelf, wall outlet fitting in splashback, with pre-assembled concealed valve

	Art. No.	Recommended miscellaneous	Art. No.
white, ProShield	5261 000 000	Design mirror, SP.FR600.R1	6744 001 899
		Shelf, AS.400.S	8270 000 980
		Shelf, AS.600.S	8271 000 980
		Shelf, AS.600.HT	8271 140 980
		Perforated block, AS.Box1	8266 000 671
		Box, AS.Box2	8267 000 671

WP . S19L . 1R

Price reduction

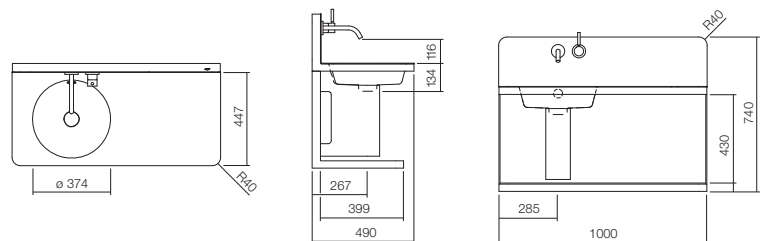

Washplace for renovation, rectangular, w/h/d 1000/740/490 mm, sink round, left, glazed steel, with overflow, bracket, steel bracket, powder finish, black matte, pressure hoses 600mm, included fixing set, valve cap, glazed in the basin colour, Ø 74 mm, bottle trap, bottle trap cover in matt black, glass shelf, wall outlet fitting in splashback, with pre-assembled concealed valve

	Art. No.	Recommended miscellaneous	Art. No.
white, ProShield	5267 000 000	Design mirror, SP.FR600.R1	6744 001 899
		Shelf, AS.400.S	8270 000 980
		Shelf, AS.600.S	8271 000 980
		Shelf, AS.600.HT	8271 140 980
		Perforated block, AS.Box1	8266 000 671
		Box, AS.Box2	8267 000 671

Washplaces – S19-series (Steel19)

Mounting and connection measurements > see Page 194

WP . S19L . 2

Price reduction

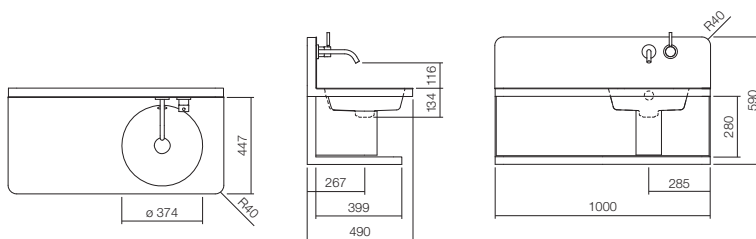

Washplace, rectangular, w/h/d 1000/590/490 mm, sink round, right, glazed steel, with overflow, bracket, steel bracket, powder finish, black matte, included fixing set, valve cap, glazed in the basin colour, $\varnothing 74$ mm, bottle trap, bottle trap cover in matt black, glass shelf, wall outlet fitting in splashback, with pre-assembled concealed valve

Art. No.

white, ProShield

5262 000 000

Recommended miscellaneous

Design mirror, SP.FR600.R1
Shelf, AS.400.S
Shelf, AS.600.S
Shelf, AS.600.HT
Perforated block, AS.Box1
Box, AS.Box2

Art. No.

6744 001 899
8270 000 980
8271 000 980
8271 140 980
8266 000 671
8267 000 671

WP . S19L . 2R

Price reduction

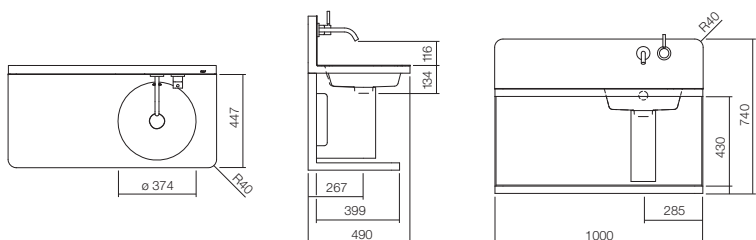

Washplace for renovation, rectangular, w/h/d 1000/740/490 mm, sink round, right, glazed steel, with overflow, bracket, steel bracket, powder finish, black matte, pressure hoses 600mm, included fixing set, valve cap, glazed in the basin colour, $\varnothing 74$ mm, bottle trap, bottle trap cover in matt black, glass shelf, wall outlet fitting in splashback, with pre-assembled concealed valve

Art. No.

white, ProShield

5268 000 000

Recommended miscellaneous

Design mirror, SP.FR600.R1
Shelf, AS.400.S
Shelf, AS.600.S
Shelf, AS.600.HT
Perforated block, AS.Box1
Box, AS.Box2

Art. No.

6744 001 899
8270 000 980
8271 000 980
8271 140 980
8266 000 671
8267 000 671

Washplaces – WF-series (Work.Frame)

Mounting and connection measurements > see Page 194/195

WP . WF20 . 1

Price reduction

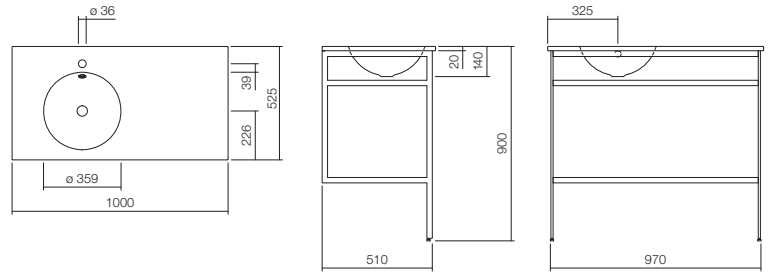

Washplace, rectangular, w/h/d 1000/900/525 mm, sink round, left, washstand cover 20mm, glazed steel, with one tap hole, with overflow, steel bracket, powder finish, black matte, included fixing set, glass shelf, overflow set

	Art. No.
white, ProShield	5271 000 000

Fittings information

Impact area approx. 129 – 169 mm from middle of tap hole.
For parameters, see page 20.

Recommended miscellaneous	Art. No.
Bottle trap cover, SV.WF20.1.2	8113 000 980
Bottle trap cover for renovation, SV.WF20.1.2R	8113 999 980
Bottle trap, Sl.3	8312 000 978
Drain valve, VT.4	8319 000 000
Drain valve, VT.5	8320 000 000
Overflow rosette, UR.1	8321 000 330
Design mirror, SP.FR375.S1	6740 001 899
Shelf, AS.400.S	8270 000 980

WP . WF20 . 2

Price reduction

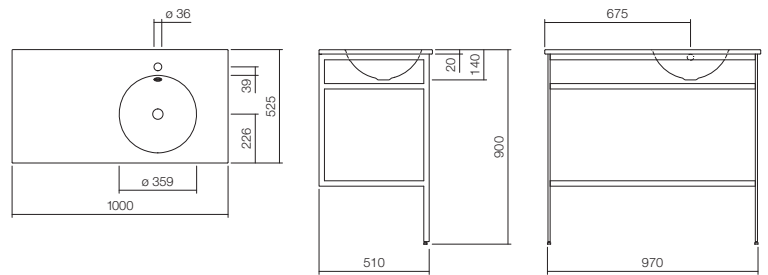

Washplace, rectangular, w/h/d 1000/900/525 mm, sink round, right, washstand cover 20mm, glazed steel, with one tap hole, with overflow, steel bracket, powder finish, black matte, included fixing set, glass shelf, overflow set

	Art. No.
white, ProShield	5272 000 000

Fittings information

Impact area approx. 129 – 169 mm from middle of tap hole.
For parameters, see page 20.

Recommended miscellaneous	Art. No.
Bottle trap cover, SV.WF20.1.2	8113 000 980
Bottle trap cover for renovation, SV.WF20.1.2R	8113 999 980
Bottle trap, Sl.3	8312 000 978
Drain valve, VT.4	8319 000 000
Drain valve, VT.5	8320 000 000
Overflow rosette, UR.1	8321 000 330
Design mirror, SP.FR375.S1	6740 001 899
Shelf, AS.400.S	8270 000 980

Washplaces – WF-series (Work.Frame)

Mounting and connection measurements > see Page 195

WP . WF20 . 3

Price reduction

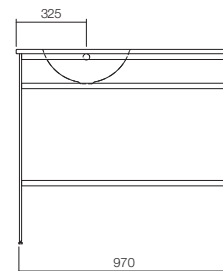
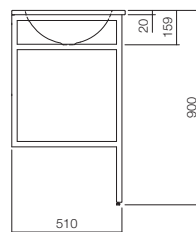
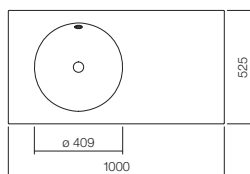

Washplace, rectangular, w/h/d 1000/900/525 mm, sink round, left, washstand cover 20mm, glazed steel, without tap hole, with overflow, steel bracket, powder finish, black matte, included fixing set, glass shelf, overflow set

	Art. No.
white, ProShield	5273 000 000

Recommended miscellaneous	Art. No.
Bottle trap cover, SV.WF20.3.4	8114 000 980
Bottle trap, Sl.3	8312 000 978
Drain valve, VT.4	8319 000 000
Drain valve, VT.5	8320 000 000
Overflow rosette, UR.1	8321 000 330
Design mirror, SP.FR375.S1	6740 001 899
Shelf, AS.400.S	8270 000 980
Perforated block, AS.Box1	8266 000 671

Fittings information

Impact area approx. 148 – 208 mm from rear edge of basin.
For parameters, see page 20.

WP . WF20 . 4

Price reduction

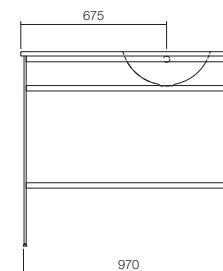
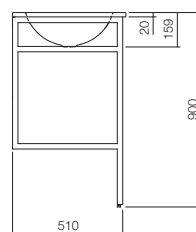
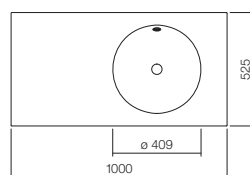

Washplace, rectangular, w/h/d 1000/900/525 mm, sink round, right, washstand cover 20mm, glazed steel, without tap hole, with overflow, steel bracket, powder finish, black matte, included fixing set, glass shelf, overflow set

	Art. No.
white, ProShield	5274 000 000

Recommended miscellaneous	Art. No.
Bottle trap cover, SV.WF20.3.4	8114 000 980
Bottle trap, Sl.3	8312 000 978
Drain valve, VT.4	8319 000 000
Drain valve, VT.5	8320 000 000
Overflow rosette, UR.1	8321 000 330
Design mirror, SP.FR375.S1	6740 001 899
Shelf, AS.400.S	8270 000 980
Perforated block, AS.Box1	8266 000 671

Fittings information

Impact area approx. 148 – 208 mm from rear edge of basin.
For parameters, see page 20.

Washplaces – WF-series (Work.Frame)

Mounting and connection measurements > see Page 195

WP.WF100.1

Price reduction

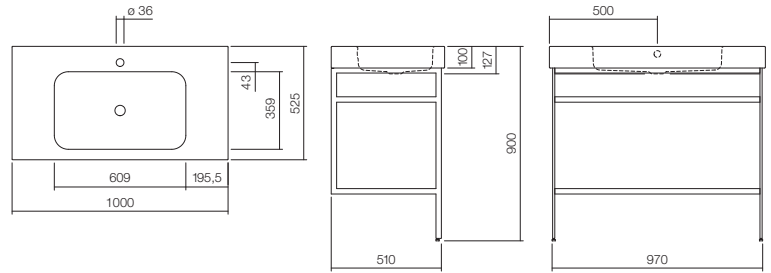

Washplace, rectangular, w/h/d 1000/900/525 mm, sink rectangular, centred, washstand cover 100mm, glazed steel, with one tap hole, with overflow, steel bracket, powder finish, black matte, included fixing set, glass shelf, overflow set

	Art. No.
white, ProShield	5270 000 000

Fittings information

Impact area approx. 105 – 155 mm from middle of tap hole.
For parameters, see page 20.

Recommended miscellaneous	Art. No.
Bottle trap cover, SV.WF100.1	8112 000 980
Bottle trap cover for renovation, SV.WF100.1R	8112 999 980
Bottle trap, Sl.3	8312 000 978
Drain valve, VT.4	8319 000 000
Drain valve, VT.5	8320 000 000
Overflow rosette, UR.1	8321 000 330
Design mirror, SP.FR750.R1	6745 001 899
Shelf, AS.400.S	8270 000 980

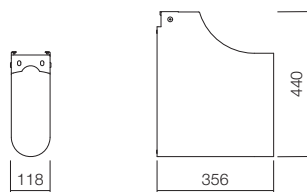
Accessoires – WF-series (Work.Frame)**SV.WF20.1.2****Price reduction**

Bottle trap cover, w/h/d 118/440/356 mm, matt black, Powder coated, suitable for: WP.WF20.1, WP.WF20.2, angle valve distance 80mm maximum

Art. No.

8113 000 980

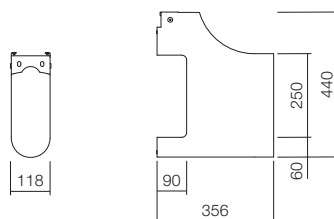
SV.WF20.1.2R**Price reduction**

Bottle trap cover for renovation, w/h/d 118/440/356 mm, matt black, Powder coated, with side cutouts, suitable for: WP.WF20.1, WP.WF20.2, angle valve distance ;>80mm possible

Art. No.

8113 999 980

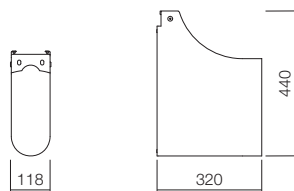
SV.WF20.3.4**Price reduction**

Bottle trap cover, w/h/d 118/440/320 mm, matt black, Powder coated, suitable for: WP.WF20.3, WP.WF20.4

Art. No.

8114 000 980

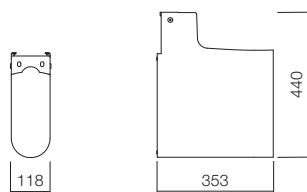
SV.WF100.1**Price reduction**

Bottle trap cover, w/h/d 118/440/353 mm, matt black, Powder coated, suitable for: WP.WF100.1, angle valve distance 80mm maximum

Art. No.

8112 000 980

Accessoires – WF-series (Work.Frame)

SV . WF100 . 1R

Price reduction



Bottle trap cover for renovation, w/h/d 118/440/354 mm, matt black, Powder coated, with side cutouts, suitable for: WP.WF100.1, angle valve distance ;>80mm possible

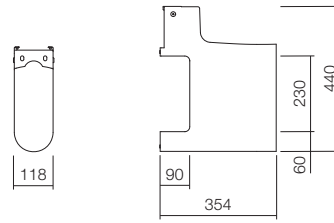

Art. No.









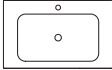

8112 999 980

Washplaces with floor cabinets

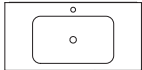
WP

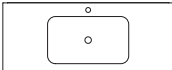
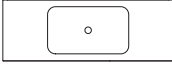
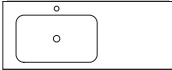

Folio
Washplace
WP.Folio8
Moonstone
1254 x 350 x 450mm

Width of washplace			
below 300mm	350 – 580mm	645 – 750mm	over 800mm
	 <p>WP.Folio11 381 x 363mm Page 146</p>  <p>WP.Folio12 381 x 363mm Page 146</p>		
			 <p>WP.Folio1 804 x 500mm Page 147</p>  <p>WP.Folio2 804 x 450mm Page 147</p>  <p>WP.Folio3 1004 x 500mm Page 148</p>  <p>WP.Folio4 1004 x 450mm Page 148</p>  <p>WP.Folio5 1254 x 500mm Page 149</p>  <p>WP.Folio6 1254 x 450mm Page 149</p>  <p>WP.Folio7 1254 x 500mm Page 150</p>  <p>WP.Folio8 1254 x 450mm Page 150</p>  <p>WP.Folio9 1254 x 500mm Page 151</p>  <p>WP.Folio10 1254 x 450mm Page 151</p>

Round, wall-mounted

Rectangular, wall-mounted

Washplaces – FO-series (Folio)

Mounting and connection measurements > see Page 195

WP.Folio11

Price reduction



Washplace, rectangular, w/h/d 381/361/363 mm, sink round, centred, Ø 272 mm, sink depth 82 mm, glazed steel, ProShield, with one tap hole, without overflow, washable cabinet, handle-free with push-to-open, door strike to the left, fixing set, drain valve, valve cap, white glazed, Ø 63 mm, space-saving bottle trap

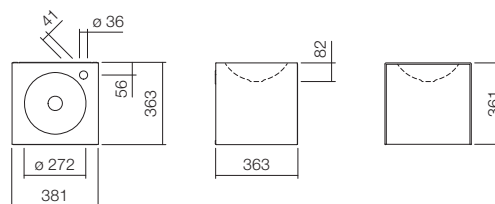

	Art. No.
wood effect laminate brushed oak	5161 816 000
silk-matt finish grey fossil	5161 810 000
silk-matt finish moonstone	5161 811 000
silk-matt finish shadow earth	5161 813 000
silk-matt finish white	5161 814 000

Fittings information

Impact area approx. 107 – 140 mm from middle of tap hole.
For parameters, see page 20.

Recommended miscellaneous	Art. No.
Design mirror, SP.FR375.S1	6740 001 899
Shelf, AS.400.S	8270 000 980
Shelf, AS.600.S	8271 000 980
Perforated block, AS.Box1	8266 000 671
Box, AS.Box2	8267 000 671

WP.Folio12

Price reduction



Washplace, rectangular, w/h/d 381/361/363 mm, sink round, centred, Ø 272 mm, sink depth 82 mm, glazed steel, ProShield, without tap hole, without overflow, washable cabinet, handle-free with push-to-open, door strike to the left, fixing set, drain valve, valve cap, white glazed, Ø 63 mm, space-saving bottle trap

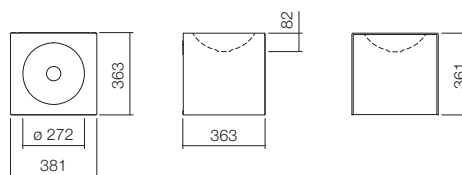

	Art. No.
wood effect laminate brushed oak	5161 516 000
silk-matt finish grey fossil	5161 510 000
silk-matt finish moonstone	5161 511 000
silk-matt finish shadow earth	5161 513 000
silk-matt finish white	5161 514 000

Fittings information

Impact area approx. 110 – 140 mm from rear edge of basin.
For parameters, see page 20.

Recommended miscellaneous	Art. No.
Design mirror, SP.FR375.S1	6740 001 899
Shelf, AS.400.S	8270 000 980
Shelf, AS.600.S	8271 000 980
Perforated block, AS.Box1	8266 000 671
Box, AS.Box2	8267 000 671

Washplaces – FO-series (Folio)

Mounting and connection measurements > see Page 196

WP.Folio1

Price reduction

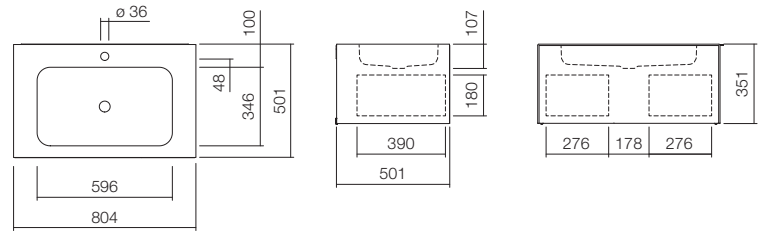

Washplace, rectangular, w/h/d 804/351/501 mm, sink rectangular, centred, w/h/d 596/107/346 mm, glazed steel, ProShield, with one tap hole, without overflow, washable cabinet, handle-free with push-to-open, full extension, fixing set, drain valve, valve cap, white glazed, Ø 74 mm, space-saving bottle trap



	Art. No.
wood effect laminate brushed oak	5155 816 000
silk-matt finish grey fossil	5155 810 000
silk-matt finish moonstone	5155 811 000
silk-matt finish shadow earth	5155 813 000
silk-matt finish white	5155 814 000

Version
With overflow

Fittings information
Impact area approx. 130 – 165 mm from middle of tap hole.
For parameters, see page 20.

Recommended miscellaneous	Art. No.
Design mirror, SP.FR600.R1	6744 001 899
Shelf, AS.400.S	8270 000 980
Shelf, AS.600.S	8271 000 980
Perforated block, AS.Box1	8266 000 671

WP.Folio2

Price reduction

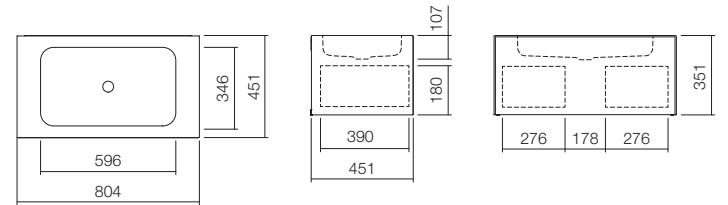

Washplace, rectangular, w/h/d 804/351/451 mm, sink rectangular, centred, w/h/d 596/107/346 mm, glazed steel, ProShield, without tap hole, without overflow, washable cabinet, handle-free with push-to-open, full extension, fixing set, drain valve, valve cap, white glazed, Ø 74 mm, space-saving bottle trap



	Art. No.
wood effect laminate brushed oak	5155 516 000
silk-matt finish grey fossil	5155 510 000
silk-matt finish moonstone	5155 511 000
silk-matt finish shadow earth	5155 513 000
silk-matt finish white	5155 514 000

Version
With overflow

Fittings information
Impact area approx. 135 – 170 mm from rear edge of basin.
For parameters, see page 20.

Recommended miscellaneous	Art. No.
Design mirror, SP.FR600.R1	6744 001 899
Shelf, AS.400.S	8270 000 980
Shelf, AS.600.S	8271 000 980
Perforated block, AS.Box1	8266 000 671

Washplaces – FO-series (Folio)

Mounting and connection measurements > see Page 196

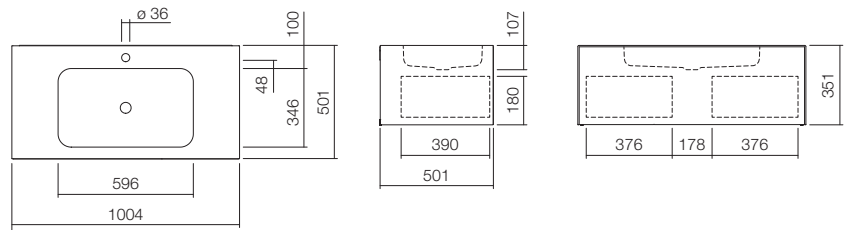
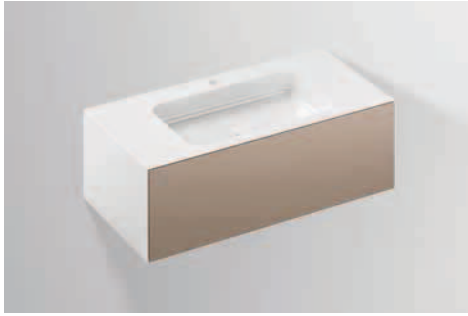
WP.Folio3**Price reduction**

Washplace, rectangular, w/h/d 1004/351/501 mm, sink rectangular, centred, w/h/d 596/107/346 mm, glazed steel, ProShield, with one tap hole, without overflow, washable cabinet, handle-free with push-to-open, full extension, fixing set, drain valve, valve cap, white glazed, Ø 74 mm, space-saving bottle trap



brushed oak



grey fossil



moonstone



shadow earth

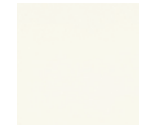

white

Art. No.

wood effect laminate brushed oak	5156 816 000
silk-matt finish grey fossil	5156 810 000
silk-matt finish moonstone	5156 811 000
silk-matt finish shadow earth	5156 813 000
silk-matt finish white	5156 814 000

Version

With overflow

Fittings information

Impact area approx. 130 – 165 mm from middle of tap hole.
For parameters, see page 20.

Recommended miscellaneous

Design mirror, SP.FR600.R1
Shelf, AS.400.S
Shelf, AS.600.S
Perforated block, AS.Box1

Art. No.

6744 001 899
8270 000 980
8271 000 980
8266 000 671

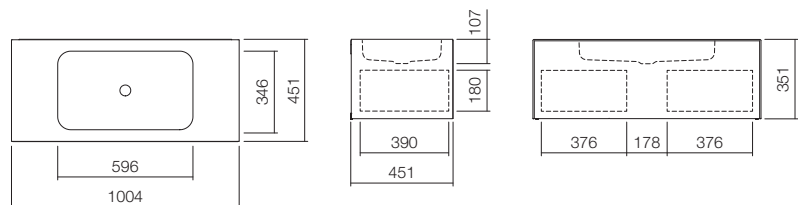
WP.Folio4**Price reduction**

Washplace, rectangular, w/h/d 1004/351/451 mm, sink rectangular, centred, w/h/d 596/107/346 mm, glazed steel, ProShield, without tap hole, without overflow, washable cabinet, handle-free with push-to-open, full extension, fixing set, drain valve, valve cap, white glazed, Ø 74 mm, space-saving bottle trap



brushed oak



grey fossil



moonstone



shadow earth

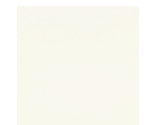

white

Art. No.

wood effect laminate brushed oak	5156 516 000
silk-matt finish grey fossil	5156 510 000
silk-matt finish moonstone	5156 511 000
silk-matt finish shadow earth	5156 513 000
silk-matt finish white	5156 514 000

Version

With overflow

Fittings information

Impact area approx. 135 – 170 mm from rear edge of basin.
For parameters, see page 20.

Recommended miscellaneous

Design mirror, SP.FR600.R1
Shelf, AS.400.S
Shelf, AS.600.S
Perforated block, AS.Box1

Art. No.

6744 001 899
8270 000 980
8271 000 980
8266 000 671

Washplaces – FO-series (Folio)

Mounting and connection measurements > see Page 196

WP.Folio5

Price reduction

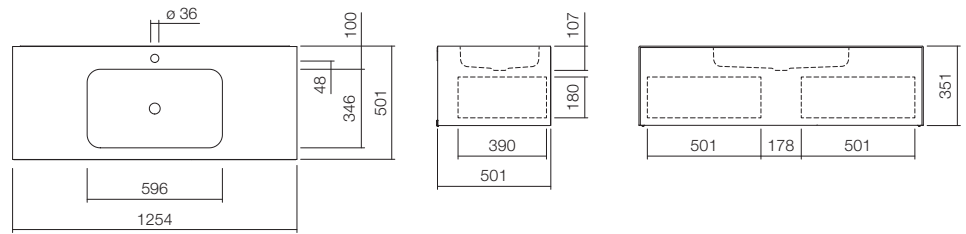
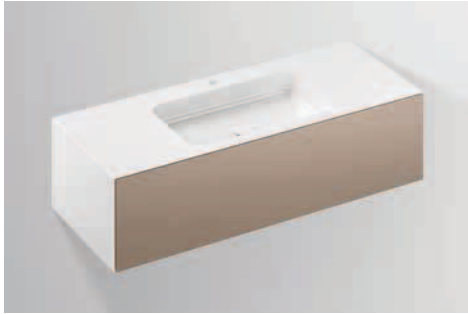

Washplace, rectangular, w/h/d 1254/351/501 mm, sink rectangular, centred, w/h/d 596/107/346 mm, glazed steel, ProShield, with one tap hole, without overflow, washable cabinet, handle-free with push-to-open, full extension, fixing set, drain valve, valve cap, white glazed, Ø 74 mm, space-saving bottle trap



	Art. No.
wood effect laminate brushed oak	5157 816 000
silk-matt finish grey fossil	5157 810 000
silk-matt finish moonstone	5157 811 000
silk-matt finish shadow earth	5157 813 000
silk-matt finish white	5157 814 000

Version
With overflow

Fittings information
Impact area approx. 130 – 165 mm from middle of tap hole.
For parameters, see page 20.

Recommended miscellaneous	Art. No.
Design mirror, SP.FR600.R1	6744 001 899
Shelf, AS.400.S	8270 000 980
Shelf, AS.600.S	8271 000 980
Perforated block, AS.Box1	8266 000 671

WP.Folio6

Price reduction

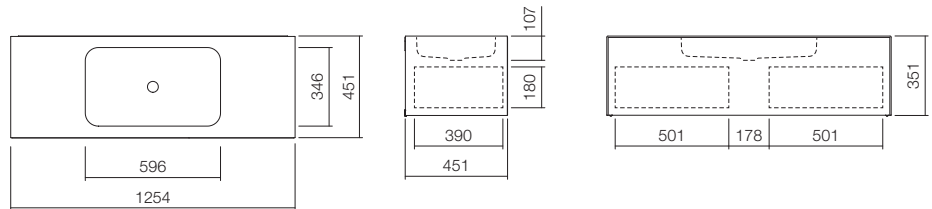
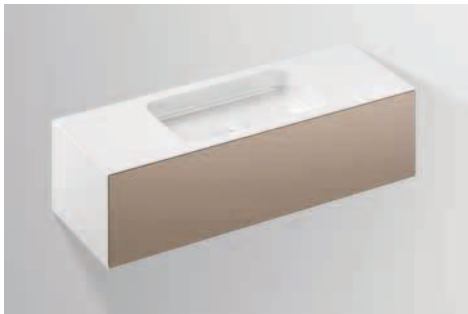

Washplace, rectangular, w/h/d 1254/351/451 mm, sink rectangular, centred, w/h/d 596/107/346 mm, glazed steel, ProShield, without tap hole, without overflow, washable cabinet, handle-free with push-to-open, full extension, fixing set, drain valve, valve cap, white glazed, Ø 74 mm, space-saving bottle trap



	Art. No.
wood effect laminate brushed oak	5157 516 000
silk-matt finish grey fossil	5157 510 000
silk-matt finish moonstone	5157 511 000
silk-matt finish shadow earth	5157 513 000
silk-matt finish white	5157 514 000

Version
With overflow

Fittings information
Impact area approx. 135 – 170 mm from rear edge of basin.
For parameters, see page 20.

Recommended miscellaneous	Art. No.
Design mirror, SP.FR600.R1	6744 001 899
Shelf, AS.400.S	8270 000 980
Shelf, AS.600.S	8271 000 980
Perforated block, AS.Box1	8266 000 671

Washplaces – FO-series (Folio)

Mounting and connection measurements > see Page 196

WP.Folio7

Price reduction

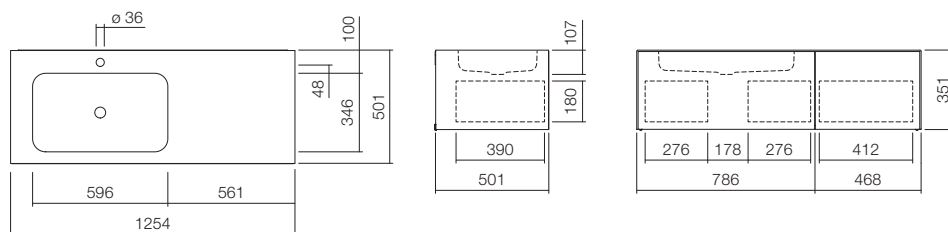

Washplace, rectangular, w/h/d 1254/351/501 mm, sink rectangular, left, w/h/d 596/107/346 mm, glazed steel, ProShield, with one tap hole, without overflow, washtable cabinet, handle-free with push-to-open, two full extensions, fixing set, drain valve, valve cap, white glazed, Ø 74 mm, space-saving bottle trap



brushed oak grey fossil moonstone shadow earth white

Art. No.

wood effect laminate brushed oak	5158 816 000
silk-matt finish grey fossil	5158 810 000
silk-matt finish moonstone	5158 811 000
silk-matt finish shadow earth	5158 813 000
silk-matt finish white	5158 814 000

Version

With overflow

Fittings information

Impact area approx. 130 – 165 mm from middle of tap hole.
For parameters, see page 20.

Recommended miscellaneous

Design mirror, SP.FR600.R1
Shelf, AS.400.S
Shelf, AS.600.S
Perforated block, AS.Box1

Art. No.

6744 001 899
8270 000 980
8271 000 980
8266 000 671

WP.Folio8

Price reduction

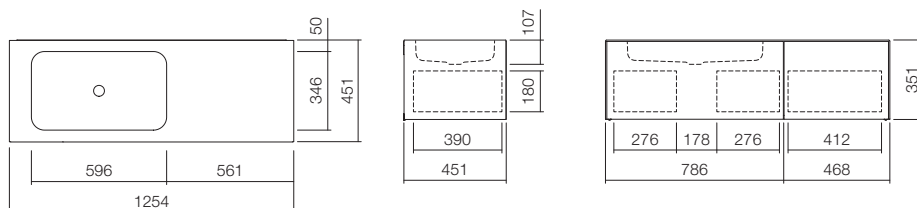

Washplace, rectangular, w/h/d 1254/351/451 mm, sink rectangular, left, w/h/d 596/107/346 mm, glazed steel, ProShield, without tap hole, without overflow, washtable cabinet, handle-free with push-to-open, two full extensions, fixing set, drain valve, valve cap, white glazed, Ø 74 mm, space-saving bottle trap



brushed oak grey fossil moonstone shadow earth white

Art. No.

wood effect laminate brushed oak	5158 516 000
silk-matt finish grey fossil	5158 510 000
silk-matt finish moonstone	5158 511 000
silk-matt finish shadow earth	5158 513 000
silk-matt finish white	5158 514 000

Version

With overflow

Fittings information

Impact area approx. 135 – 170 mm from rear edge of basin.
For parameters, see page 20.

Recommended miscellaneous

Design mirror, SP.FR600.R1
Shelf, AS.400.S
Shelf, AS.600.S
Perforated block, AS.Box1

Art. No.

6744 001 899
8270 000 980
8271 000 980
8266 000 671

Washplaces – FO-series (Folio)

Mounting and connection measurements > see Page 197

WP.Folio9

Price reduction

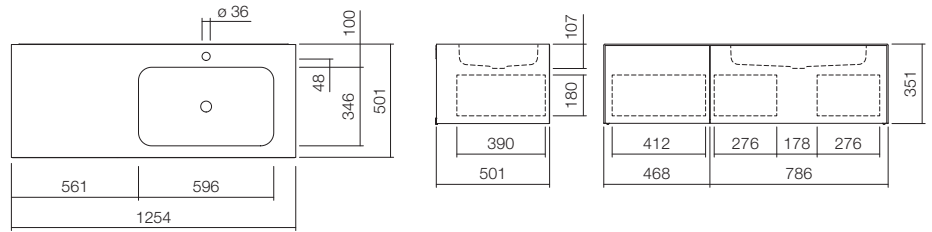

Washplace, rectangular, w/h/d 1254/351/501 mm, sink rectangular, right, w/h/d 596/107/346 mm, glazed steel, ProShield, with one tap hole, without overflow, washtable cabinet, handle-free with push-to-open, two full extensions, fixing set, drain valve, valve cap, white glazed, Ø 74 mm, space-saving bottle trap



	Art. No.
wood effect laminate brushed oak	5159 816 000
silk-matt finish grey fossil	5159 810 000
silk-matt finish moonstone	5159 811 000
silk-matt finish shadow earth	5159 813 000
silk-matt finish white	5159 814 000

Version
With overflow

Fittings information
Impact area approx. 130 – 165 mm from middle of tap hole.
For parameters, see page 20.

Recommended miscellaneous	Art. No.
Design mirror, SP.FR600.R1	6744 001 899
Shelf, AS.400.S	8270 000 980
Shelf, AS.600.S	8271 000 980
Perforated block, AS.Box1	8266 000 671

WP.Folio10

Price reduction

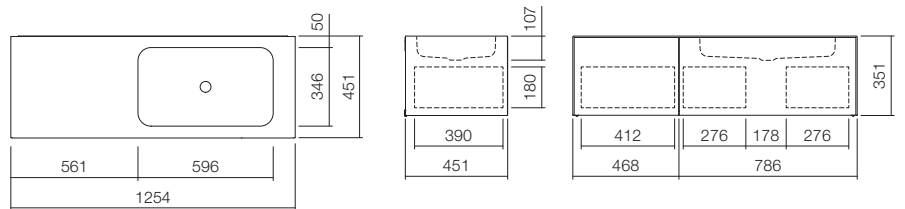

Washplace, rectangular, w/h/d 1254/351/451 mm, sink rectangular, right, w/h/d 596/107/346 mm, glazed steel, ProShield, without tap hole, without overflow, washtable cabinet, handle-free with push-to-open, two full extensions, fixing set, drain valve, valve cap, white glazed, Ø 74 mm, space-saving bottle trap



	Art. No.
wood effect laminate brushed oak	5159 516 000
silk-matt finish grey fossil	5159 510 000
silk-matt finish moonstone	5159 511 000
silk-matt finish shadow earth	5159 513 000
silk-matt finish white	5159 514 000

Version
With overflow

Fittings information
Impact area approx. 135 – 170 mm from rear edge of basin.
For parameters, see page 20.

Recommended miscellaneous	Art. No.
Design mirror, SP.FR600.R1	6744 001 899
Shelf, AS.400.S	8270 000 980
Shelf, AS.600.S	8271 000 980
Perforated block, AS.Box1	8266 000 671

Tall cabinets – FO-series (Folio)

HS . F01250 . L

Price reduction



Cupboard, rectangular, w/h/d 300/1246/303 mm, one door, handle-free with push-to-open, door stop on the left, width with door open 355 mm (opening angle 105°), glazed side bracket on the right, white, included fixing set, 4 glass shelves, without dowels (to be adjusted to constructional situation)

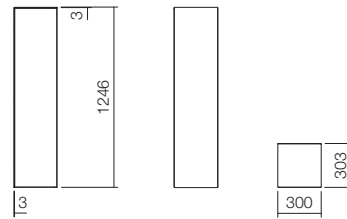

brushed oak



grey fossil



moonstone



shadow earth

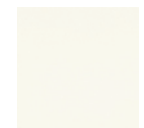

white

Art. No.

wood effect laminate brushed oak	6323 990 016
silk-matt finish grey fossil	6323 990 010
silk-matt finish moonstone	6323 990 011
silk-matt finish shadow earth	6323 990 013
silk-matt finish white	6323 990 014

HS . F01250 . R

Price reduction



Cupboard, rectangular, w/h/d 300/1246/303 mm, one door, handle-free with push-to-open, door stop on the right, width with door open 355 mm (opening angle 105°), glazed side bracket on the left, white, included fixing set, 4 glass shelves, without dowels (to be adjusted to constructional situation)

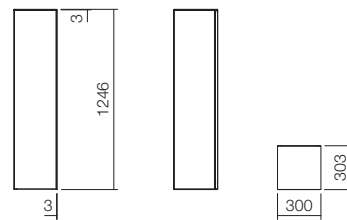

brushed oak



grey fossil



moonstone



shadow earth

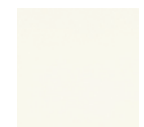

white

Art. No.

wood effect laminate brushed oak	6323 690 016
silk-matt finish grey fossil	6323 690 010
silk-matt finish moonstone	6323 690 011
silk-matt finish shadow earth	6323 690 013
silk-matt finish white	6323 690 014





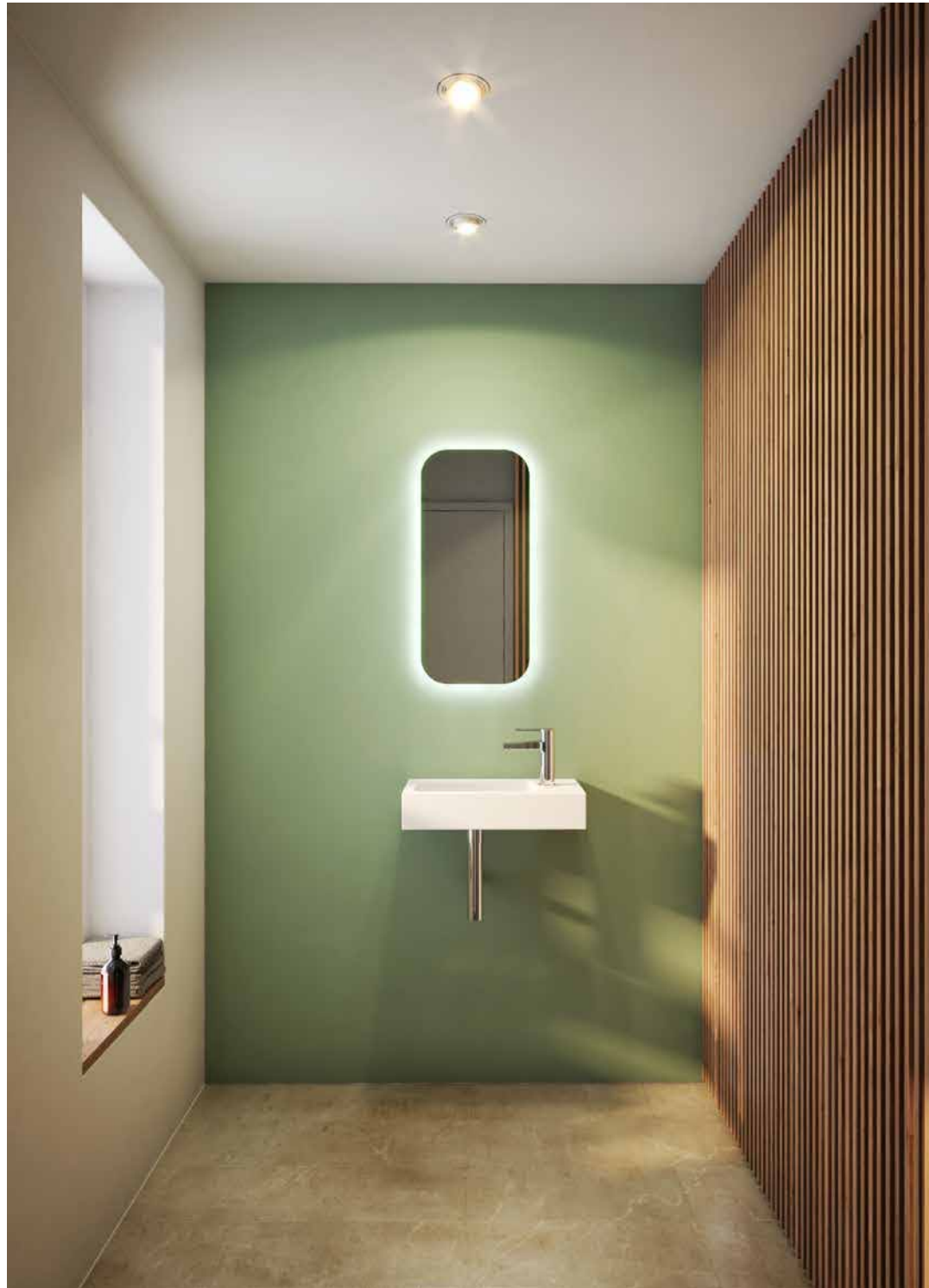

Folio
Waschplatz
WP.Folio8
Oak brushed
1254 x 350 x 450 mm

Washplaces with fitting **Sets**

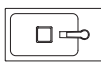

Washplace
SET . WT . XS500H . L
500 x 100 x 268 mm

Width of washplace			
300 – 375 mm	400 – 500 mm		
 <p>SET . SB . K300 . GS ø 300 mm, height 106 mm P. 157</p>	 <p>SET . SB . K360 . GS ø 360 mm, height 130 mm P. 158</p>	Round, wall-mounted	
 <p>SET . AB . KE325 ø 325 mm, height 106 mm P. 156</p>	 <p>SET . AB . KE375 ø 375 mm, height 116 mm P. 156/157</p>		
		 <p>SET . WP . Insert1 485 x 321 mm P.159</p>	Rectangular
		 <p>SET . WT . XS500H . L 500 x 268 mm P. 158/159</p>	

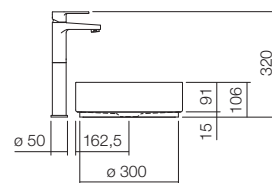
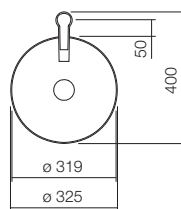
SET including fittingMounting and connection measurements > www.alape.com**SET . AB . KE325**

Sit-on basin, round, Ø 325 mm, height 106 mm, glazed steel, white, ProShield, without tap hole, without overflow, inklusive fixing set, drain valve, valve cap, white glazed, Ø 63 mm, black spacer ring, with single-lever basin mixer with raised base without pop-up waste, Chrome, projection 110 mm, tap height 320 mm, height to aerator 258 mm, spout rigid, circular, air-enriched flow, aerator adjustable 0-10°, flow rate max. 5 l/min, 2x screw-in M 10 x 1 pressure hose, leak-tested, connection thread 3/8", hole diameter 32 - 36 mm

	Art. No.	Recommended miscellaneous	Art. No.
white, ProShield	0633 001 000	Bottle trap, Sl.2 Bottle trap, Sl.3	8306 000 978 8312 000 978

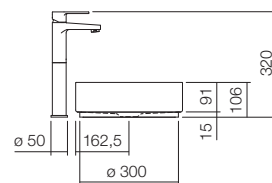
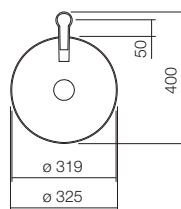
SET . AB . KE325

Sit-on basin, round, Ø 325 mm, height 106 mm, glazed steel, white, ProShield, without tap hole, without overflow, inklusive fixing set, drain valve, valve cap, white glazed, Ø 63 mm, black spacer ring, with single-lever basin mixer with raised base without pop-up waste, Matt black, projection 110 mm, tap height 320 mm, height to aerator 258 mm, spout rigid, circular, air-enriched flow, aerator adjustable 0-10°, flow rate max. 5 l/min, 2x screw-in M 10 x 1 pressure hose, leak-tested, connection thread 3/8", hole diameter 32 - 36 mm

	Art. No.	Recommended miscellaneous	Art. No.
white, ProShield	0633 002 000	Bottle trap, Sl.3	8312 000 980

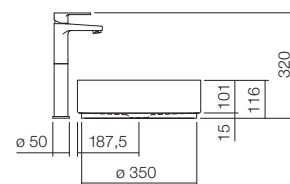
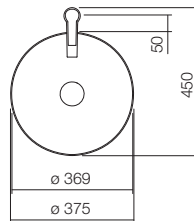
SET . AB . KE375

Sit-on basin, round, Ø 375 mm, height 116 mm, glazed steel, white, ProShield, without tap hole, without overflow, inklusive fixing set, drain valve, valve cap, white glazed, Ø 63 mm, black spacer ring, with single-lever basin mixer with raised base without pop-up waste, Chrome, projection 110 mm, tap height 320 mm, height to aerator 258 mm, spout rigid, circular, air-enriched flow, aerator adjustable 0-10°, flow rate max. 5 l/min, 2x screw-in M 10 x 1 pressure hose, leak-tested, connection thread 3/8", hole diameter 32 - 36 mm

	Art. No.	Recommended miscellaneous	Art. No.
white, ProShield	0634 001 000	Bottle trap, Sl.2 Bottle trap, Sl.3	8306 000 978 8312 000 978

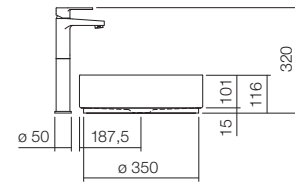
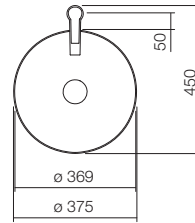
SET including fittingMounting and connection measurements > www.alape.com**SET . AB . KE375**

Sit-on basin, round, Ø 375 mm, height 116 mm, glazed steel, white, ProShield, without tap hole, without overflow, inklusive fixing set, drain valve, valve cap, white glazed, Ø 63 mm, black spacer ring, with single-lever basin mixer with raised base without pop-up waste, Matt black, projection 110 mm, tap height 320 mm, height to aerator 258 mm, spout rigid, circular, air-enriched flow, aerator adjustable 0-10°, flow rate max. 5 l/min, 2x screw-in M 10 x 1 pressure hose, leak-tested, connection thread 3/8", hole diameter 32 - 36 mm

	Art. No.	Recommended miscellaneous	Art. No.
white, ProShield	0634 002 000	Bottle trap, Sl.3	8312 000 980

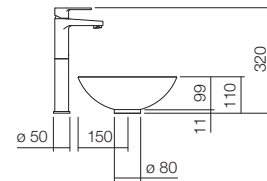
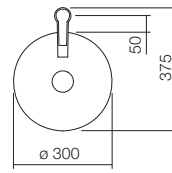
SET . SB . K300 . GS

Dish basin, round, Ø 300 mm, height 110 mm, glazed steel, white, ProShield, without tap hole, without overflow, inklusive fixing set, drain valve, valve cap, white glazed, Ø 63 mm, white spacer ring, with single-lever basin mixer with raised base without pop-up waste, Chrome, projection 110 mm, tap height 320 mm, height to aerator 258 mm, spout rigid, circular, air-enriched flow, aerator adjustable 0-10°, flow rate max. 5 l/min, 2x screw-in M 10 x 1 pressure hose, leak-tested, connection thread 3/8", hole diameter 32 - 36 mm

	Art. No.	Recommended miscellaneous	Art. No.
white, ProShield	0635 001 000	Bottle trap, Sl.2 Bottle trap, Sl.3	8306 000 978 8312 000 978

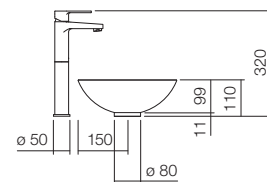
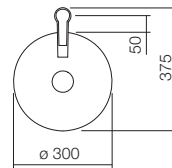
SET . SB . K300 . GS

Dish basin, round, Ø 300 mm, height 110 mm, glazed steel, white, ProShield, without tap hole, without overflow, inklusive fixing set, drain valve, valve cap, white glazed, Ø 63 mm, white spacer ring, with single-lever basin mixer with raised base without pop-up waste, Matt black, projection 110 mm, tap height 320 mm, height to aerator 258 mm, spout rigid, circular, air-enriched flow, aerator adjustable 0-10°, flow rate max. 5 l/min, 2x screw-in M 10 x 1 pressure hose, leak-tested, connection thread 3/8", hole diameter 32 - 36 mm

	Art. No.	Recommended miscellaneous	Art. No.
white, ProShield	0635 002 000	Bottle trap, Sl.3	8312 000 980

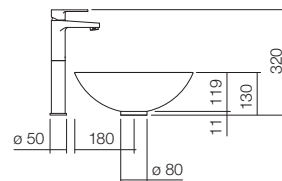
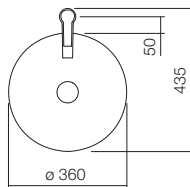
SET including fitting**SET . SB . K360 . GS**

Dish basin, round, Ø 360 mm, height 130 mm, glazed steel, white, ProShield, without tap hole, without overflow, inklusive fixing set, drain valve, valve cap, white glazed, Ø 63 mm, white spacer ring, with single-lever basin mixer with raised base without pop-up waste, Chrome, projection 110 mm, tap height 320 mm, height to aerator 258 mm, spout rigid, circular, air-enriched flow, aerator adjustable 0-10°, flow rate max. 5 l/min, 2x screw-in M 10 x 1 pressure hose, leak-tested, connection thread 3/8", hole diameter 32 - 36 mm

	Art. No.	Recommended miscellaneous	Art. No.
white, ProShield	0636 001 000	Bottle trap, Sl.2 Bottle trap, Sl.3	8306 000 978 8312 000 978

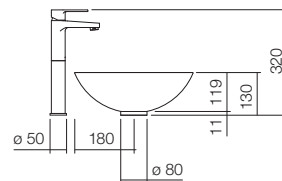
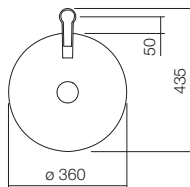
SET . SB . K360 . GS

Dish basin, round, Ø 360 mm, height 130 mm, glazed steel, white, ProShield, without tap hole, without overflow, inklusive fixing set, drain valve, valve cap, white glazed, Ø 63 mm, white spacer ring, with single-lever basin mixer with raised base without pop-up waste, Matt black, projection 110 mm, tap height 320 mm, height to aerator 258 mm, spout rigid, circular, air-enriched flow, aerator adjustable 0-10°, flow rate max. 5 l/min, 2x screw-in M 10 x 1 pressure hose, leak-tested, connection thread 3/8", hole diameter 32 - 36 mm

	Art. No.	Recommended miscellaneous	Art. No.
white, ProShield	0636 002 000	Bottle trap, Sl.3	8312 000 980

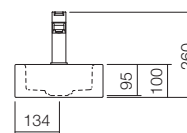
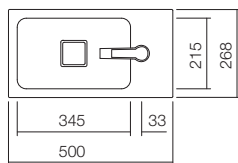
SET . WT . XS500H . L

Washstand, rectangular, w/h/d 500/100/268 mm, glazed steel, white, ProShield, with one tap hole, without overflow, inklusive fixing set, drain valve, valve cap, white glazed, Ø 68 mm, with single-lever basin mixer without pop-up waste, Chrome, projection 110 mm, tap height 160 mm, height to aerator 98 mm, spout rigid, circular, air-enriched flow, aerator adjustable 0-10°, flow rate max. 5 l/min, 2x screw-in M 10 x 1 pressure hose, leak-tested, connection thread 3/8", hole diameter 32 - 36 mm

	Art. No.	Recommended miscellaneous	Art. No.
white, ProShield	0639 001 000	Bottle trap, Sl.2 Bottle trap, Sl.3	8306 000 978 8312 000 978

SET including fitting

Mounting and connection measurements > see Page 197

SET . WT . XS500H . L

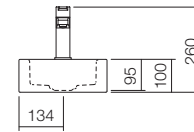
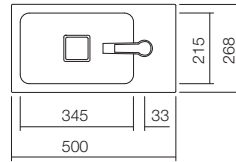

Washstand, rectangular, w/h/d 500/100/268 mm, glazed steel, white, ProShield, with one tap hole, without overflow, inklusive fixing set, drain valve, valve cap, white glazed, Ø 68 mm, with single-lever basin mixer without pop-up waste, Matt black, projection 110 mm, tap height 160 mm, height to aerator 98 mm, spout rigid, circular, air-enriched flow, aerator adjustable 0-10°, flow rate max. 5 l/min, 2x screw-in M 10 x 1 pressure hose, leak-tested, connection thread 3/8", hole diameter 32 - 36 mm

	Art. No.
white, ProShield	0639 002 000

Recommended miscellaneous	Art. No.
Bottle trap, SI.3	8312 000 980

SET . WP . Insert1

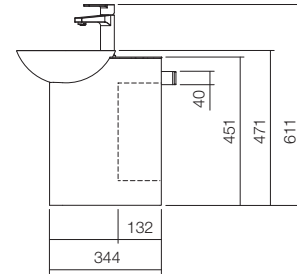
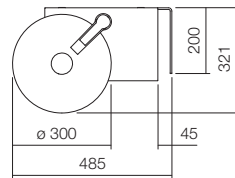

Washplace, rectangular, w/h/d 485/471/321 mm, glazed steel, white, ProShield, with one tap hole, without overflow, shelf cabinet right, frame, chrome steel, powder finish, white, inklusive fixing set, drain valve, valve cap, white glazed, Ø 63 mm, with single-lever basin mixer without pop-up waste, Chrome, projection 110 mm, tap height 160 mm, height to aerator 98 mm, spout rigid, circular, air-enriched flow, aerator adjustable 0-10°, flow rate max. 5 l/min, 2x screw-in M 10 x 1 pressure hose, leak-tested, connection thread 3/8", hole diameter 32 - 36 mm

	Art. No.
white, ProShield	0637 001 000

SET . WP . Insert1

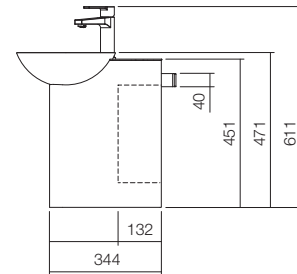
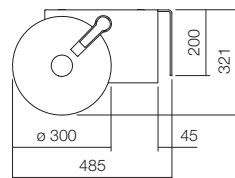

Washplace, rectangular, w/h/d 485/471/321 mm, glazed steel, white, ProShield, with one tap hole, without overflow, shelf cabinet right, frame, chrome steel, powder finish, white, inklusive fixing set, drain valve, valve cap, white glazed, Ø 63 mm, with single-lever basin mixer without pop-up waste, Matt black, projection 110 mm, tap height 160 mm, height to aerator 98 mm, spout rigid, circular, air-enriched flow, aerator adjustable 0-10°, flow rate max. 5 l/min, 2x screw-in M 10 x 1 pressure hose, leak-tested, connection thread 3/8", hole diameter 32 - 36 mm

	Art. No.
white, ProShield	0637 002 000

Bucket sinks

AG



Bucket sink
AG . STAHLFORM510Ü
510 x 365 x 330mm

Bucket sinks

The multi-purpose basin for basements, garages, workshops, gardens and lofts. With coloured edge protection and high-drawn, integrated back splash. The Alape original from the fifties. Proven a thousand times over through robustness and quality.

Bucket sinks – AG-series**AG.Stahlform 510Ü**

Bucket sink, rectangular, w/h/d 510/365/330 mm, without tap hole, with overflow, PVC edge, black, drain and overflow fitting with chain and plug, Minimum order quantity 1 pallet (24 pc)

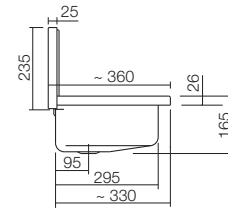
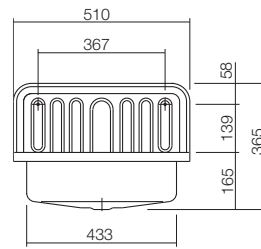
**Art. No.**

white

1200 000 000

AG.Stahlform 510Ü

Bucket sink, rectangular, w/h/d 510/365/330 mm, without tap hole, with overflow, PVC edge, black, bottle trap, drain and overflow fitting with chain and plug

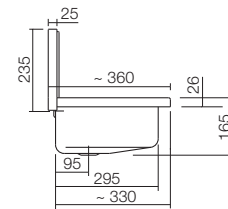
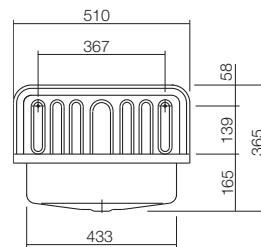
**Art. No.**

bicolor

1205 000 180

UTENSILO

Shelf, w/h/d 517/558/270 mm, Powder coated, steel shelf suitable for Alape AG.STAHLFORM510Ü bucket sinks

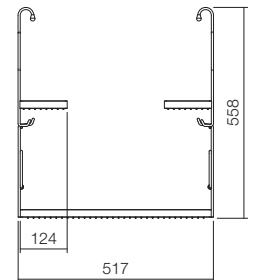
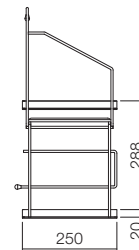
**Art. No.**

matt black

8902 000 980

AG .CONTRA505

Bucket sink, rectangular, w/h/d 505/360/330 mm, without tap hole, without overflow, PVC edge, black, drain valve with chain and plug, Minimum order quantity 1 pallet (24 pc)

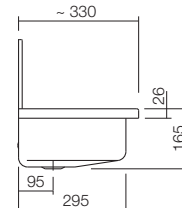
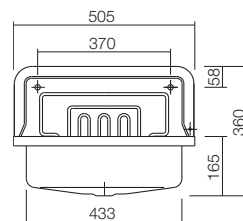
**Art. No.**

white

1300 000 000

Bucket sinks – AG-series

Aluminium grid



Aluminium grid, w/h/d 520/55/285 mm, aluminium, natural

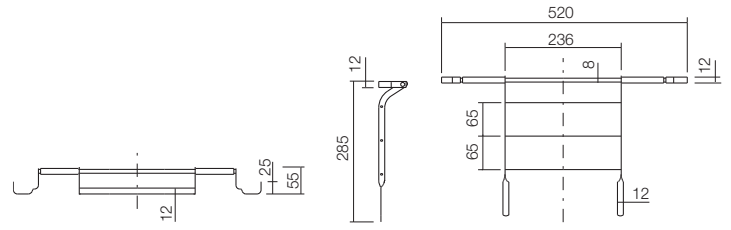

Art. No.

8901 000 722

Shelf system – Assist

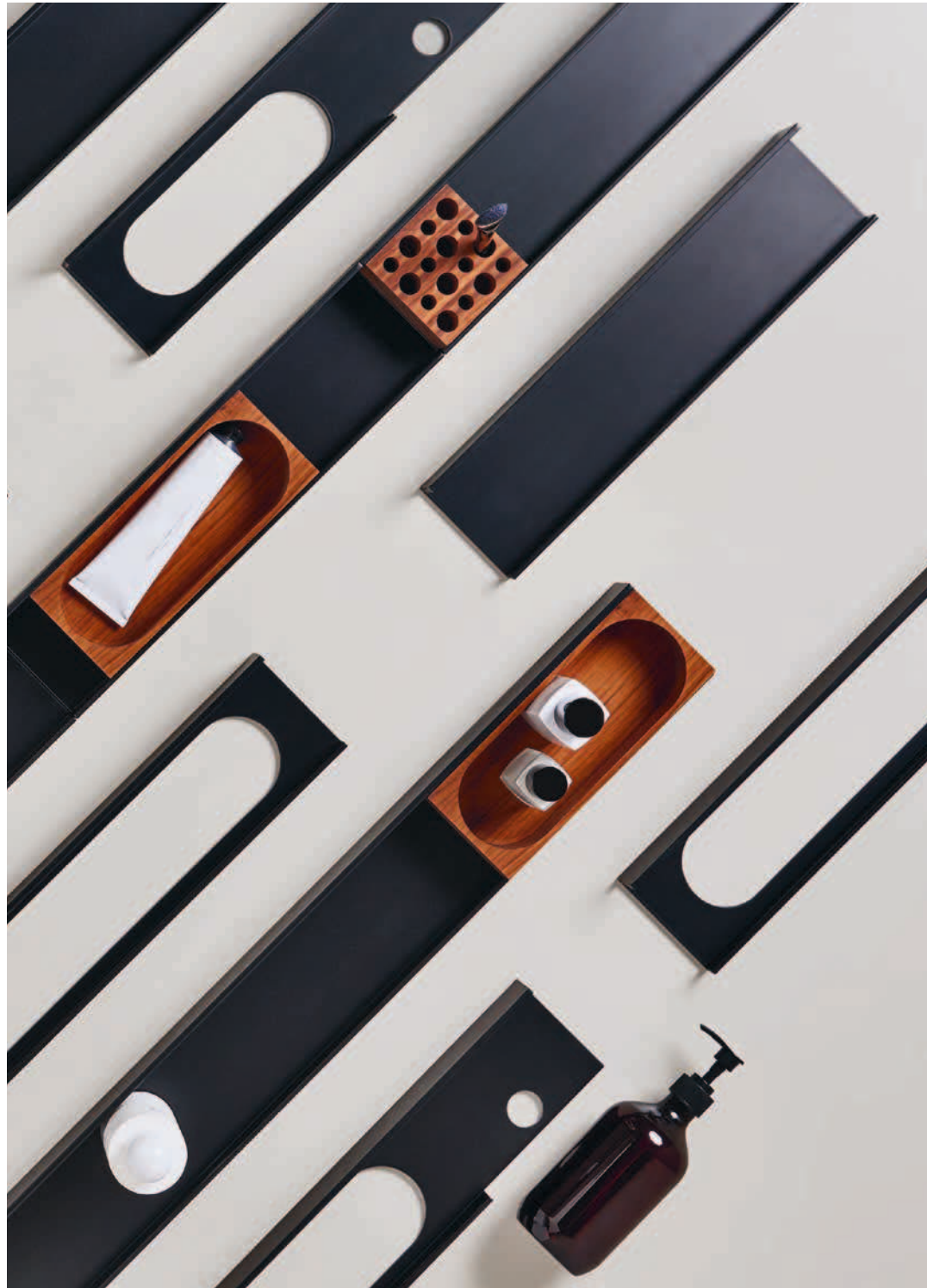

Width — Shelves

Assist — Shelves

400mm

AS . 400 . S
400 x 50 x 100mm
Page 166

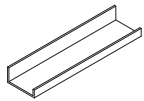

600mm

AS . 600 . S
600 x 50 x 100mm
Page 166

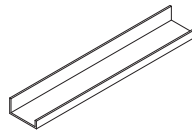

800mm

AS . 800 . S
800 x 50 x 100mm
Page 166

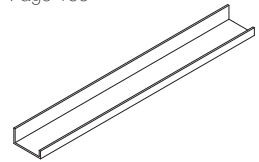

AS . 400 . HT . L/R
400 x 196 x 111
Page 167

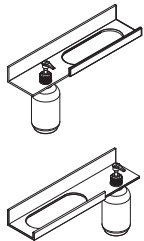

AS . 600 . HT
600 x 50 x 100mm
Page 166

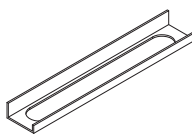

Assist — Accessories

AS . Box1
89 x 44 x 89mm
Page 167



AS . Box2
225 x 44 x 89mm
Page 167



AS . 160 . TPH
160 x 50 x 100mm
Page 168



Assist — Shower shelves

AS . 400 . S
400 x 50 x 100mm
Page 168

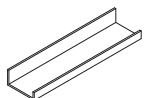

AS . 134 . L02
134 x 50 x 85mm
Page 168



AS . 225 . L03
225 x 50 x 85mm
Page 168



Assist – Shelves**AS . 400 . S****Price reduction**

Shelf, rectangular, w/h/d 400/50/100 mm, aluminium, Powder coated, without cutouts, included fixing set, without dowels (to be adjusted to constructional situation)



matt black
matt white

Art. No.

8270 000 980
8270 000 331

AS . 600 . S**Price reduction**

Shelf, rectangular, w/h/d 600/50/100 mm, aluminium, Powder coated, without cutouts, included fixing set, without dowels (to be adjusted to constructional situation)



matt black
matt white

Art. No.

8271 000 980
8271 000 331

AS . 800 . S**Price reduction**

Shelf, rectangular, w/h/d 800/50/100 mm, aluminium, Powder coated, without cutouts, included fixing set, without dowels (to be adjusted to constructional situation)



matt black
matt white

Art. No.

8272 000 980
8272 000 331

AS . 600 . HT**Price reduction**

Shelf, rectangular, w/h/d 600/50/100 mm, aluminium, Powder coated, towel cutout central, included fixing set, without dowels (to be adjusted to constructional situation)



matt black
matt white

Art. No.

8271 140 980
8271 140 331

Assist – Shelves

AS . 400 . HT . L

Price reduction



Shelf, rectangular, w/h/d 400/196/111 mm, aluminium, Powder coated, lotion dispenser cutout right, towel cutout left, included fixing set, plastic bottle, without dowels (to be adjusted to constructional situation)

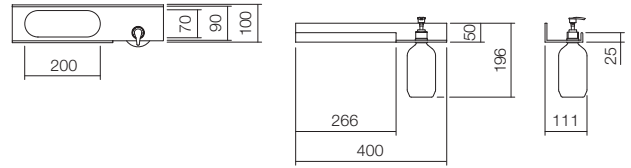

matt black
matt white

Art. No.

8270 221 980
8270 221 331

AS . 400 . HT . R

Price reduction



Shelf, rectangular, w/h/d 400/196/111 mm, aluminium, Powder coated, lotion dispenser cutout left, towel cutout, right, included fixing set, plastic bottle, without dowels (to be adjusted to constructional situation)

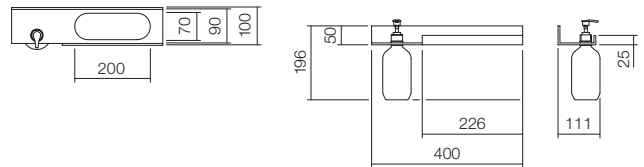

matt black
matt white

Art. No.

8270 321 980
8270 321 331

AS . Box1

Price reduction



Perforated block, rectangular, w/h/d 89/44/89 mm, american walnut, Oiled, with 16 drill holes, 12 and 17 mm diameter

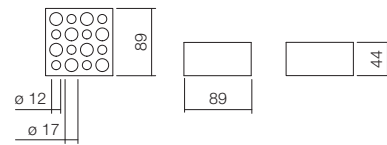

Art. No.

8266 000 671

AS . Box2

Price reduction



Box, rectangular, w/h/d 225/44/89 mm, american walnut, Oiled, with oval cutout, approx. width: 215 mm

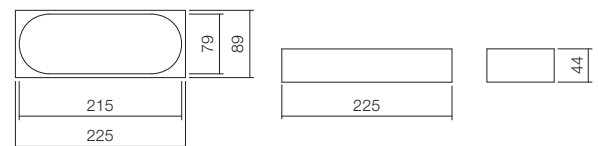

Art. No.

8267 000 671

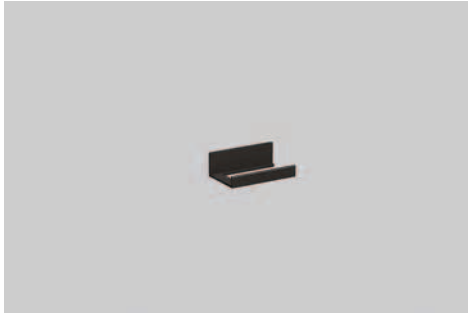
Assist – Shelves, Shower shelves**AS . 160 . TPH****Price reduction**

Toiletry, rectangular, w/h/d 160/50/100 mm, aluminium, anodized and powder coated, included fixing set, without dowels (to be adjusted to constructional situation)

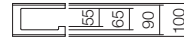

matt black
matt white

Art. No.

8274 170 981
8274 170 982

AS . 400 . S**Price reduction**

Shower shelf, rectangular, w/h/d 400/50/100 mm, aluminium, anodized and powder coated, without cutouts, included fixing set, without dowels (to be adjusted to constructional situation)

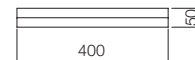

matt black
matt white

Art. No.

8270 000 981
8270 000 982

AS . 134 . L02**Price reduction**

Shower shelf, rectangular, w/h/d 134/50/85 mm, aluminium, anodized and powder coated, two lotion dispenser cutouts, included fixing set, two plastic bottles, without dowels (to be adjusted to constructional situation)

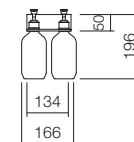

matt black
matt white

Art. No.

8274 111 981
8274 111 982

AS . 225 . L03**Price reduction**

Shower shelf, rectangular, w/h/d 225/50/85 mm, aluminium, anodized and powder coated, three lotion dispenser cutouts, included fixing set, three plastic bottles, without dowels (to be adjusted to constructional situation)

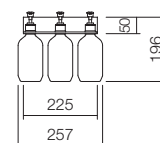
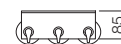

matt black
matt white

Art. No.

8274 112 981
8274 112 982





Assist
Shower shelves
AS.400.S
AS.225.L03

Design mirrors



Mirror
SP . FR375 . S1
375 x 800 x 40mm

Unisono
Washstand Bicolor
WT . RX400 . KE
400 x 900 x 442mm

Width			
375-450 mm	500-750 mm	1000 mm	
	 <p>SP.FR600.R1 ø 600 x 40mm Page 174</p>	 <p>SP.FR1000.R1 ø 1000 x 40mm Page 174</p>	Round
	 <p>SP.FR750.R1 ø 750 x 40mm Page 174</p>		
 <p>SP.FR375.S1 375 x 800 x 40mm Page 172</p>	 <p>SP.FR500.S1 500 x 1000 x 40mm Page 172</p>		Rectangular
 <p>SP.FR450.S1 450 x 800 x 40mm Page 172</p>	 <p>SP.FR600.S1 600 x 1000 x 40mm Page 173</p>		

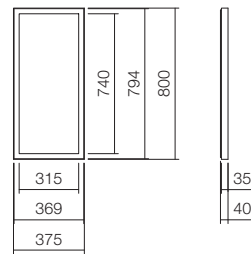
Design mirrors – rectangularMounting and connection measurements: Download www.alape.com**SP . FR375 . S1**

Design mirror, rectangular, w/h/d 375/800/40 mm, aluminium, Powder coated, indirect circumferential LED light, dimmable, 11.7 watts, luminous colour: 4,000 Kelvin, included fixing set, LED converter, touch switch and auxiliary function, without dowels (to be adjusted to constructional situation)

Art. No.

matt black
matt white

6740 001 899
6740 001 331

Technical information

Protection class IP44, Safety class 1

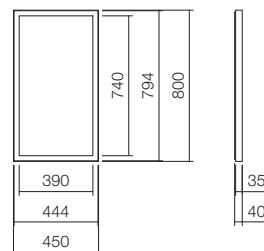
SP . FR450 . S1

Design mirror, rectangular, w/h/d 450/800/40 mm, aluminium, Powder coated, indirect circumferential LED light, dimmable, 12.6 watts, luminous colour: 4,000 Kelvin, included fixing set, LED converter, touch switch and auxiliary function, without dowels (to be adjusted to constructional situation)

Art. No.

matt black
matt white

6741 001 899
6741 001 331

Technical information

Protection class IP44, Safety class 1

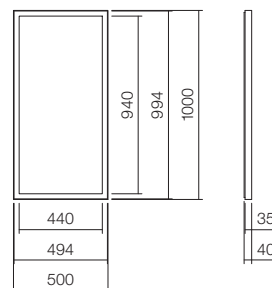
SP . FR500 . S1

Design mirror, rectangular, w/h/d 500/1000/40 mm, aluminium, Powder coated, indirect circumferential LED light, dimmable, 14 watts, luminous colour: 4,000 Kelvin, included fixing set, LED converter, touch switch and auxiliary function, without dowels (to be adjusted to constructional situation)

Art. No.

matt black
matt white

6742 001 899
6742 001 331

Technical information

Protection class IP44, Safety class 1

Design mirrors – rectangular

Mounting and connection measurements: Download www.alape.com

SP . FR600 . S1

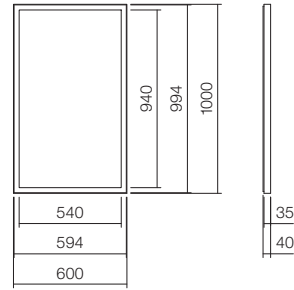

Design mirror, rectangular, w/h/d 600/1000/40 mm, aluminium, Powder coated, indirect circumferential LED light, dimmable, 15 watts, luminous colour: 4,000 Kelvin, included fixing set, LED converter, touch switch and auxiliary function, without dowels (to be adjusted to constructional situation)

Art. No.

matt black
matt white

6743 001 899
6743 001 331

Technical information

Protection class IP44, Safety class 1

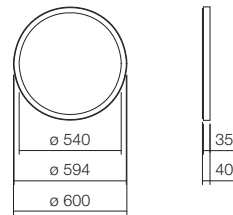
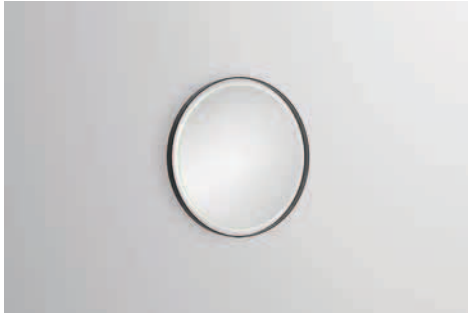
Design mirrors – roundMounting and connection measurements: Download www.alape.com**SP . FR600 . R1**

Design mirror, round, w/h/d 600/600/40 mm, aluminium, Powder coated, indirect circumferential LED light, dimmable, 9.3 watts, luminous colour: 4,000 Kelvin, included fixing set, LED converter, touch switch and auxiliary function, without dowels (to be adjusted to constructional situation)

Art. No.

matt black
matt white

6744 001 899
6744 001 331

Technical information

Protection class IP44, Safety class 1

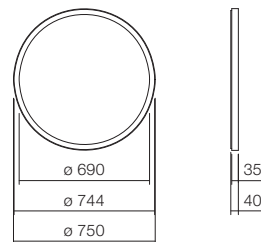
SP . FR750 . R1

Design mirror, round, w/h/d 750/750/40 mm, aluminium, Powder coated, indirect circumferential LED light, dimmable, 12.3 watts, luminous colour: 4,000 Kelvin, included fixing set, LED converter, touch switch and auxiliary function, without dowels (to be adjusted to constructional situation)

Art. No.

matt black
matt white

6745 001 899
6745 001 331

Technical information

Protection class IP44, Safety class 1

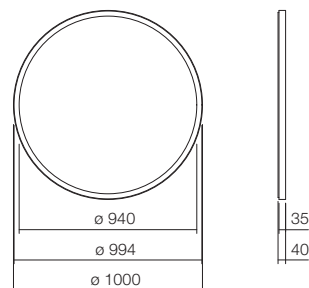
SP . FR1000 . R1

Design mirror, round, w/h/d 1000/1000/40 mm, aluminium, Powder coated, indirect circumferential LED light, dimmable, 15 watts, luminous colour: 4,000 Kelvin, included fixing set, LED converter, touch switch and auxiliary function, without dowels (to be adjusted to constructional situation)

Art. No.

matt black
matt white

6746 001 899
6746 001 331

Technical information

Protection class IP44, Safety class 1



Design mirror
SP.FR750.R1
ø 750 x 40mm

Folio
Washplace
WP.Folio7
1250 x 350 x 500mm

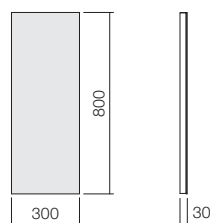
Mirrors**SP . 300**

Mirror, rectangular, w/h/d 300/800/30 mm, white powder coated side profiles, included fixing set

Art. No.

w/h/d 300/800/30 mm

6719 000 899

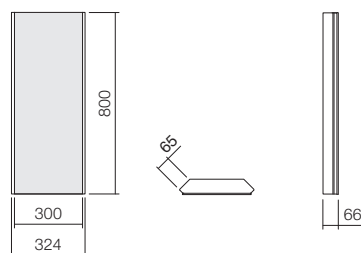
SP . 300C

Corner mirror, rectangular, w/h/d 324/800/66 mm, white powder coated side profiles, included fixing set

Art. No.

w/h/d 324/800/66 mm

6720 000 899

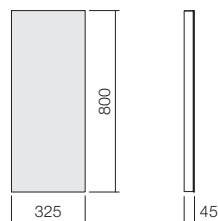
SP . 325

Mirror, rectangular, w/h/d 325/800/45 mm, aluminium frame, included fixing set

Art. No.

w/h/d 325/800/45 mm

6716 000 899

Mirrors

Mounting and connection measurements: Download www.alape.com

SP . 450

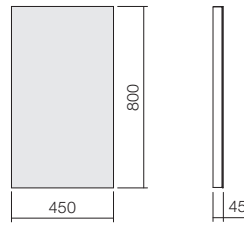
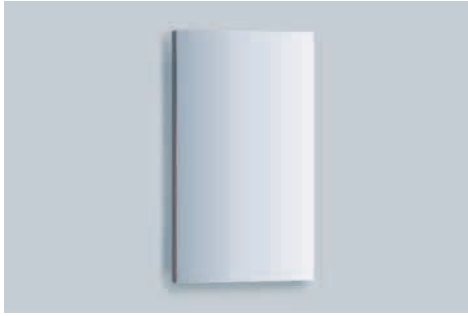

Mirror, rectangular, w/h/d 450/800/45 mm, aluminium frame, included fixing set

Art. No.

w/h/d 450/800/45 mm

6717 000 899

Accessoires



Overloopprozet

UR . 1

Mat zwart

Schachtventil, ventielkap

VT . 5

Wit

Work.Frame

Wastafelmeubel

WP . WF20 . 1

1000 x 900 x 525 mm

Accessories

SI . 2



Bottle trap, w/h/d 45/297/370 mm, chrome-plated, 1 1/4" connection thread, immersion tube, adjustable in height from 135 to 205 mm, adjustable depth from 90 to 370 mm

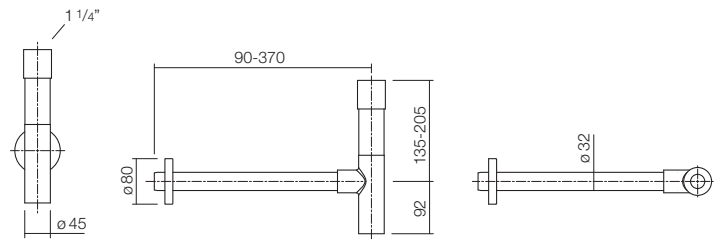

Art. No.
8306 000 978

SI . 3



Bottle trap, w/h/d 45/419.5/390 mm, 1 1/4" connection thread, immersion tube, adjustable in height from 75 to 330 mm, adjustable depth from 90 to 390 mm

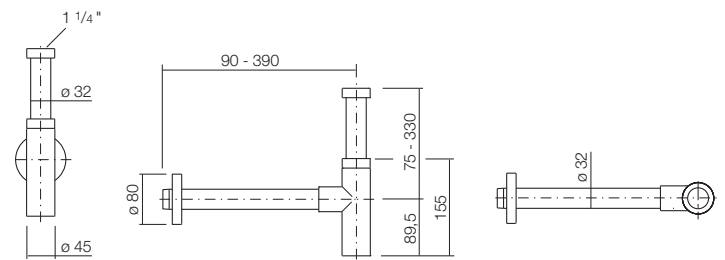

Art. No.
8312 000 978
8312 000 980
8312 000 331

EV . 3



Angle valve cover, w/h/d 45/351/49 mm, chrome-plated

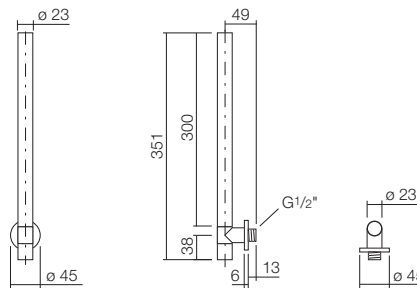

Art. No.
8110 000 978

VT . 1



Drain valve, round, w/h/d 63/74/63 mm, Ø 1 1/4", with open/closed function, this basin requires an overflow, valve cap, chrome-plated

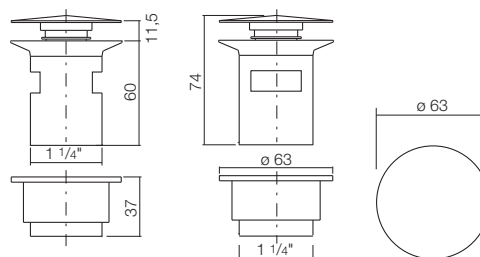

Art. No.
8302 000 978

Accessories

VT . 2



Drain valve, round, w/h/d 63/100/63 mm, Ø 1 1/4", for basins without overflow, valve cap

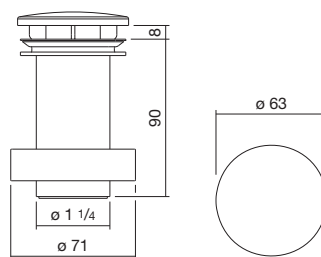

Art. No.

8304 000 978
8304 000 000

VT . 3



Drain valve, round, w/h/d 74/100/74 mm, Ø 1 1/4", for basins without overflow, valve cap

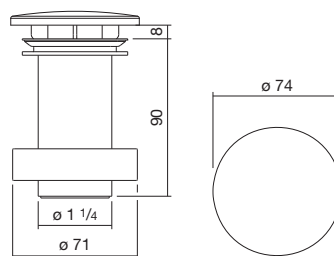

Art. No.

8305 000 978
8305 000 000

VT . 4



Drain valve, round, w/h/d 74/120/74 mm, Ø 1 1/4", with open/closed function, this basin requires an overflow, valve cap, white glazed

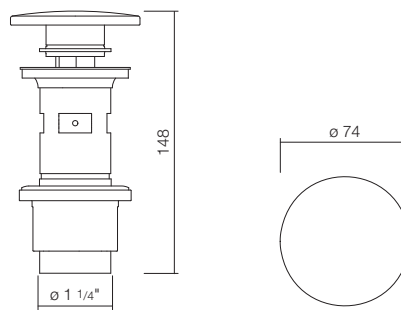

Art. No.

8319 000 000

VT . 5



Drain valve, round, w/h/d 74/106/74 mm, Ø 1 1/4", this basin requires an overflow, valve cap

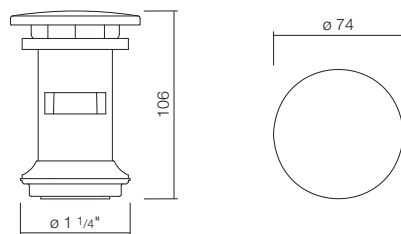

Art. No.

8320 000 978
8320 000 000

Accessories

UR.1



Overflow rosette, round, w/h/d 36/36/14 mm, suitable for Alape overflow set

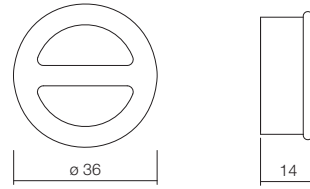

	Art. No.
matt black	8321 000 980
platinum matt	8321 000 330
white	8321 000 331

Overflow set B.1



Overflow set, w/h/d 70/235/mm, equipped for eccentric and drain valve, for basins and washstands with overflow

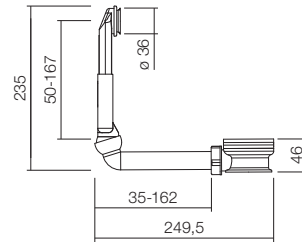

	Art. No.
	9500 280 000

Overflow set C



Overflow set, w/h/d 70/50/87 mm, equipped for drain and universal valve, for basins and washstands without overflow

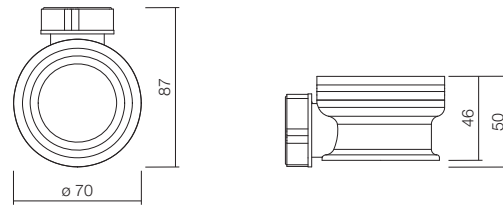

	Art. No.
	9500 410 000

Spare parts

Below you will find spare parts for our extensive range of washbasins, washstands and washplaces. The selection ranges from valve caps in different shapes, sizes and colours to siphons and accessory bags for bucket sinks. You will find the article number of the required spare part in the assembly instructions for your product. If you miss a spare part, please send a message to service@alape.com. We will be happy to advise you.

Article	Short name	Description
Valve caps		
9510 001 000	Valve cap	Valve cap, square, w/h/d 68/23/68 mm, white, glazed, with base body
9510 002 000	Valve cap	Valve cap, oval, w/h/d 390/35/90 mm, white, glazed, with base body
9510 006 000	Valve cap	Valve cap, round, w/h/d 65/30/65 mm, plastic, chrome-plated, with base body
9510 007 000	Valve cap	Valve cap, round, w/h/d 75/30/75 mm, plastic, chrome-plated, with base body
9510 009 000	Valve cap	Valve cap, round, w/h/d 63/31/63 mm, white, glazed, suitable for basins without overflow with Alape 11/4" drain valve, with base body
9510 009 180	Valve cap	Valve cap, round, w/h/d 63/31/63 mm, bicolor, glazed, suitable for basins without overflow with Alape 11/4" drain valve, with base body
9510 009 190	Valve cap	Valve cap, round, w/h/d 63/31/63 mm, dark iron, glazed, suitable for basins without overflow with Alape 11/4" drain valve, with base body
9510 010 000	Valve cap	Valve cap, round, w/h/d 74/31/74 mm, white, glazed, suitable for basins without overflow with Alape 11/4" drain valve, with base body
9510 010 180	Valve cap	Valve cap, round, w/h/d 74/31/74 mm, bicolor, glazed, suitable for basins without overflow with Alape 11/4" drain valve, with base body
9510 010 190	Valve cap	Valve cap, round, w/h/d 74/31/74 mm, dark iron, glazed, suitable for basins without overflow with Alape 11/4" drain valve, with base body
9510 018 000	Valve cap	Valve cap, round, w/h/d 84/32/84 mm, white, glazed, suitable for basins without overflow with Alape 11/4" drain valve, with base body
9510 018 081	Valve cap	Valve cap, round, w/h/d 84/32/84 mm, oyster matt, glazed, suitable for basins without overflow with Alape 11/4" drain valve, with base body
9510 018 082	Valve cap	Valve cap, round, w/h/d 84/32/84 mm, silk matt, glazed, suitable for basins without overflow with Alape 11/4" drain valve, with base body
9510 018 083	Valve cap	Valve cap, round, w/h/d 84/32/84 mm, nordic matt, glazed, suitable for basins without overflow with Alape 11/4" drain valve, with base body
9510 018 084	Valve cap	Valve cap, round, w/h/d 84/32/84 mm, gravel matt, glazed, suitable for basins without overflow with Alape 11/4" drain valve, with base body
9510 018 091	Valve cap	Valve cap, round, w/h/d 84/32/84 mm, deep green, glazed, suitable for basins without overflow with Alape 11/4" drain valve, with base body
9510 018 092	Valve cap	Valve cap, round, w/h/d 84/32/84 mm, deep blue, glazed, suitable for basins without overflow with Alape 11/4" drain valve, with base body
9510 018 093	Valve cap	Valve cap, round, w/h/d 84/32/84 mm, deep indigo, glazed, suitable for basins without overflow with Alape 11/4" drain valve, with base body
9510 019 081	Valve cap	Valve cap, round, w/h/d 92/32/92 mm, oyster matt, glazed, suitable for basins without overflow with Alape 11/4" drain valve, with base body
9510 019 082	Valve cap	Valve cap, round, w/h/d 92/32/92 mm, silk matt, glazed, suitable for basins without overflow with Alape 11/4" drain valve, with base body
9510 019 083	Valve cap	Valve cap, round, w/h/d 92/32/92 mm, nordic matt, glazed, suitable for basins without overflow with Alape 11/4" drain valve, with base body
9510 019 084	Valve cap	Valve cap, round, w/h/d 92/32/92 mm, gravel matt, glazed, suitable for basins without overflow with Alape 11/4" drain valve, with base body

Article	Short name	Description
9510 019 091	Valve cap	Valve cap, round, w/h/d 92/32/92 mm, deep green, glazed, suitable for basins without overflow with Alape 1 1/4" drain valve, with base body
9510 019 092	Valve cap	Valve cap, round, w/h/d 92/32/92 mm, deep blue, glazed, suitable for basins without overflow with Alape 1 1/4" drain valve, with base body
9510 019 093	Valve cap	Valve cap, round, w/h/d 92/32/92 mm, deep indigo, glazed, suitable for basins without overflow with Alape 1 1/4" drain valve, with base body
9510 950 590	Valve cap	Valve cap, round, w/h/d 63/32/63 mm, brass, chrome-plated, with base body
9510 950 591	Valve cap	Valve cap, round, w/h/d 73/32/73 mm, brass, chrome-plated, with base body

Bottle traps

9510 351 051	Bottle trap	Bottle trap, w/h/d 80/206/384 mm, for surface mounting, height adjustable, with horizontal outlet, plastic, white, connection thread 1 1/4"
9510 351 058	Bottle trap	Bottle trap, w/h/d 75/337/710 mm, plastic, white, 1 1/4" connection thread
9510 351 950	Bottle trap	Bottle trap, w/h/d 66/268/417 mm, flexible outlet hose, plastic, white, connection thread 1 1/4"
9510 430 307	Bottle trap	Bottle trap, w/h/d 45/296/370 mm, chrome-plated, 1 1/4" connection thread
9510 950 491	Bottle trap	Bottle trap, w/h/d 48/48/222 mm, plastic, white
9510 950 492	Bottle trap	Bottle trap, w/h/d 85/222/284 mm, plastic, white, 1 1/4" connection thread

Other spare parts

9510 106 118	Enamel paint	Enamel paint, w/h/d 87/14/21 mm, one-component, for repairs, tube content 8 ml, white
9510 350 996	Installation accessory bag	Installation accessory bag, w/h/d 80/21/80 mm, 3-part, consisting of chrome-plated spacer ring, seal and flange nut
9510 351 823	Plastic bottle	Plastic bottle, w/h/d 75/211/75 mm, amber, incl. black dispenser
9510 950 011	Installation accessory bag	Installation accessory bag, w/h/d 483/5/483 mm, 5-part, consisting of mounting brackets (4 pieces) and PVC seal, white
9510 950 042	Installation accessory bag	Installation accessory bag, w/h/d 277/31/50 mm, 5-part, consisting of mounting brackets (4 pieces) and adhesive cartridge for basin assembling, 70 ml, white
9510 950 086	Adhesive	Adhesive, w/h/d 277/31/50 mm, one-component, for basin assembling, cartridge content 70 ml, white
9510 951 078	Overflow rosette	Overflow rosette, round, w/h/d 36/36/14 mm, plastic, chrome-plated
9511 000 001	Installation accessory bag	Installation accessory bag, w/h/d 505/219/6 mm, 12-part, consisting of drain valve (6-part), chain with plug, plastic cover caps (2 pieces), grommet (2 pieces) and PVC edge profile (grey)
9511 000 003	Installation accessory bag	Installation accessory bag, w/h/d 36/153/100 mm, 20-part, consisting of drain valve (5-part), chain with stopper, plastic cover caps (2 pieces), grommet (2 pieces), screws (2 pieces) and overflow set (7-part)

Mounting and Connection Measurements

The following mounting and connection measurements can also be downloaded at www.alape.com.

Our hotline is available to answer your questions in more detail. You can reach our service team on +49(0)5321.558111.



Mounting and connection measurements

SP . 300C
No. 6720 000 899

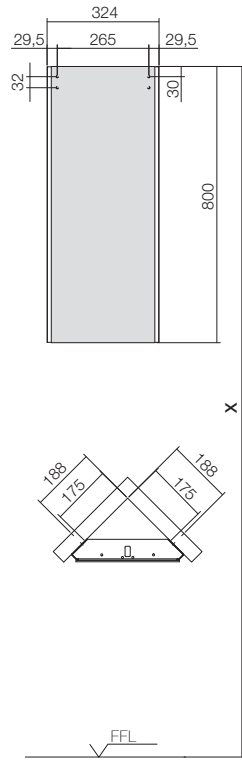

SP . 300
No. 6719 000 899

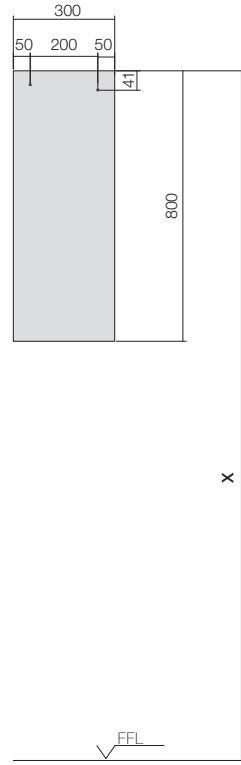

SP . 325
No. 6716 000 899

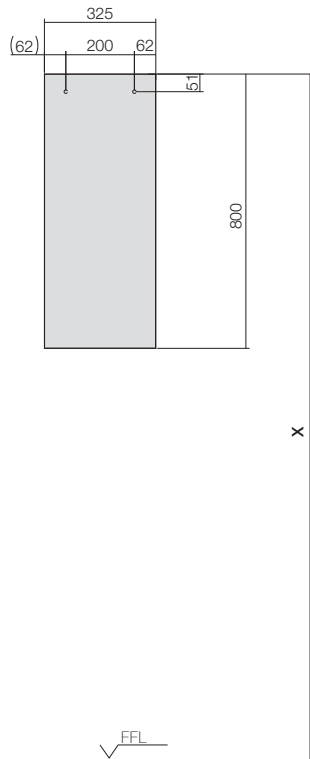

SP . 450
No. 6717 000 899

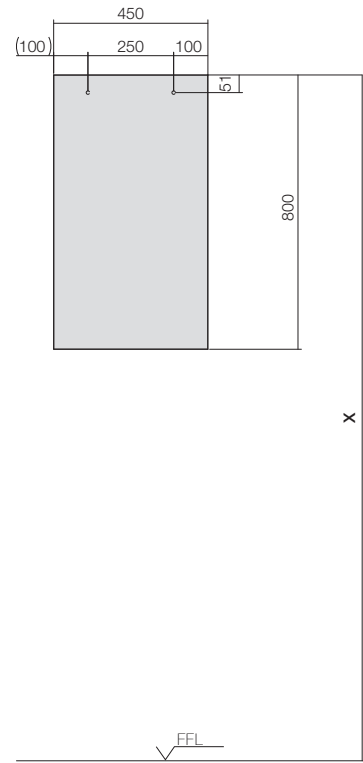

Mounting and connection measurements

WT.RX400H.CU
No. 4508 800 000

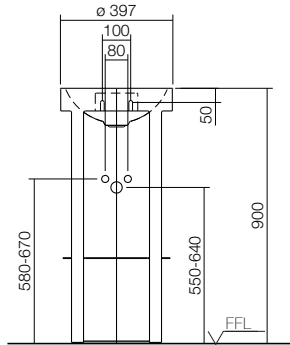

WT.RX400H.CR
No. 4509 800 240

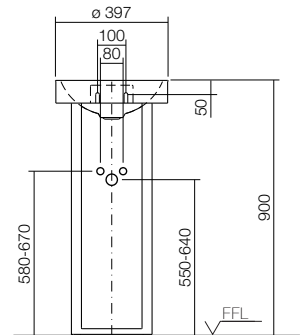

WT.RX400.CU
No. 4508 500 000

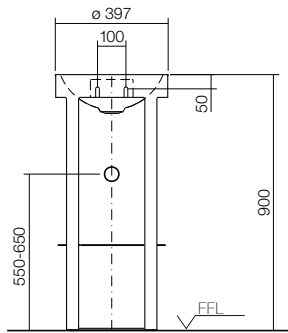

WT.RX400.CR
No. 4509 500 240

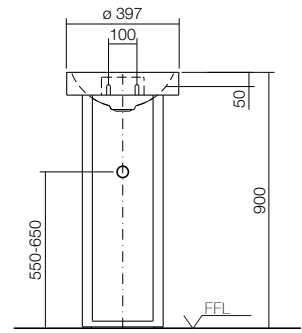

WT.RX325K
No. 4501 000 000 – with wall bracket cover

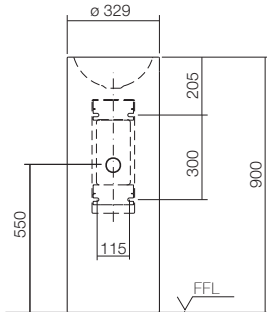

WT.RX400KH
No. 4500 000 000 – with wall bracket cover

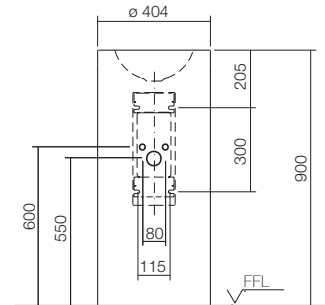

WT.RX400K
No. 4503 000 000 – with wall bracket cover

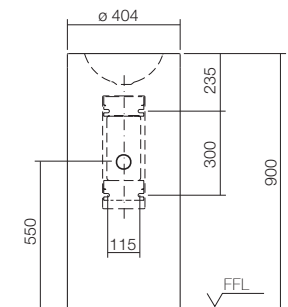

WT.RX325.KE
No. 4505 500 000 – with wall bracket cover

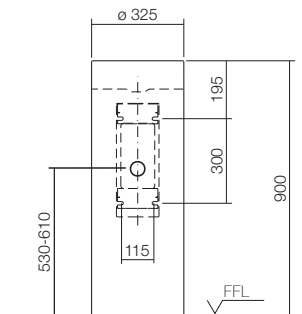

Mounting and connection measurements

WT.RX400.KE

No. 4506 500 000 – with wall bracket cover

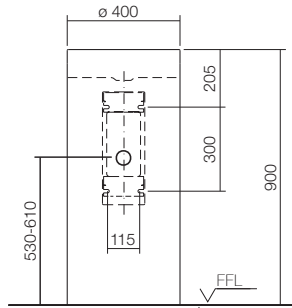

WT.RX400H.CO

No. 4507 800 000 – with wall bracket cover

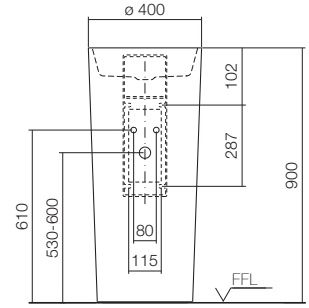

WT.RX400.CO

No. 4507 500 000 – with wall bracket cover

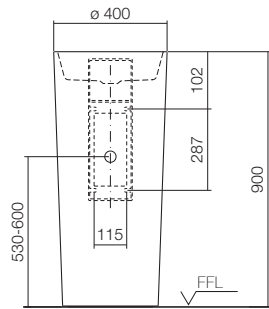

WT.RX325QS

No. 4801 000 000 – with wall bracket cover

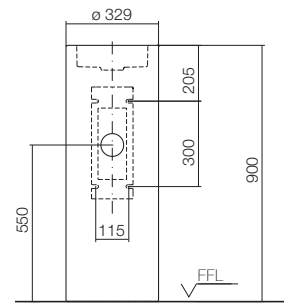

WT.RX450QS

No. 4804 000 000 – with wall bracket cover

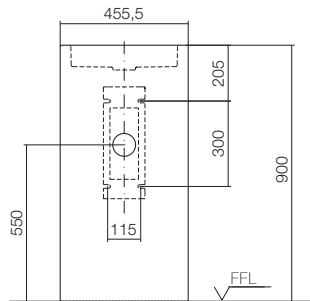

WT.RS450

No. 5054 000 000

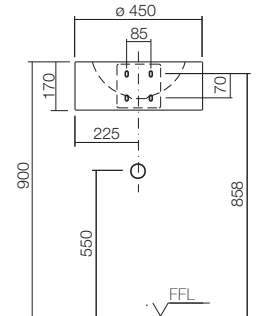

WT.RS400

No. 5052 000 000

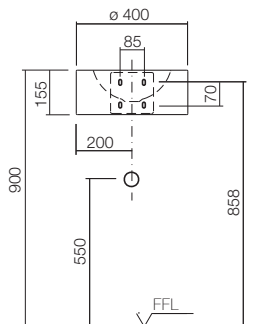

WT.RS325

No. 5041 000 000 – Visible drain

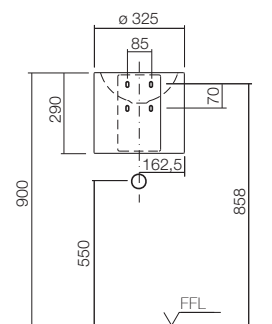

Mounting and connection measurements

WT.RS325

No. 5041 000 000 – Covered drain

We recommend:
Viega chrome-plated
pipe siphon for bidet
modell 5535
product no. 103781
from Viega

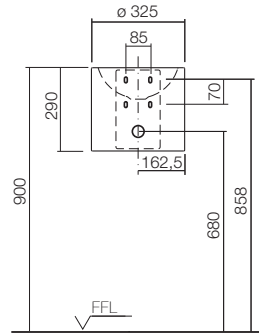

WT.C0400H

No. 5042 800 000 – with wall bracket cover

We recommend:
Space-saving trap
from Geberit
Art. No. 151.113.11.1

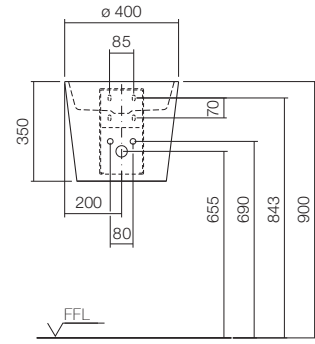

WT.C0400

No. 5042 500 000 – with wall bracket cover

We recommend:
Space-saving trap
from Geberit
Art. No. 151.113.11.1

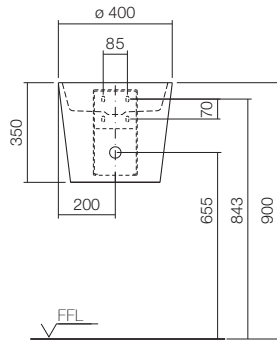

WT.IC325H

No. 4236 000 000

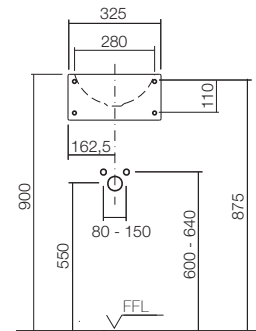

WT.IC600H

No. 4238 000 000

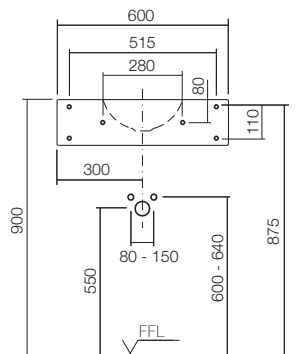

WT.IC600H.R

No. 4240 000 000

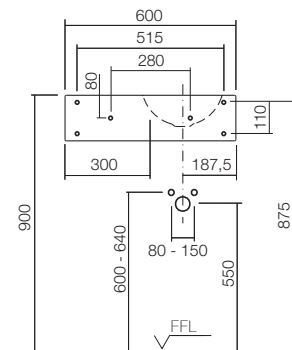

WT.IC600H.L

No. 4239 000 000

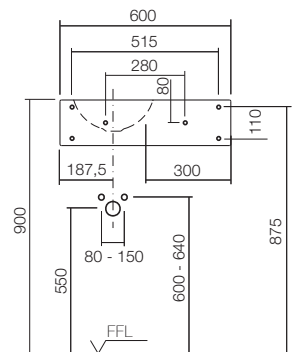

WT.MC450H

No. 4228 000 000

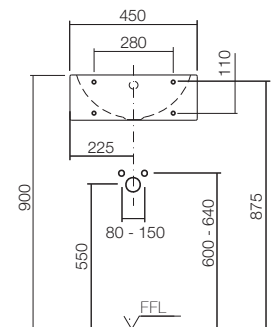

Mounting and connection measurements

WT.XS500H.R
No. 4292 000 000

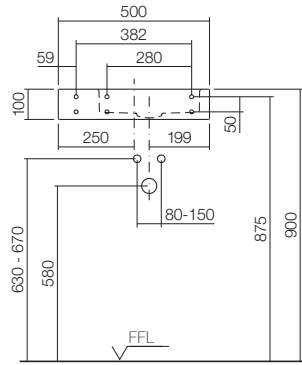

WT.XS500.L
No. 4291 000 000

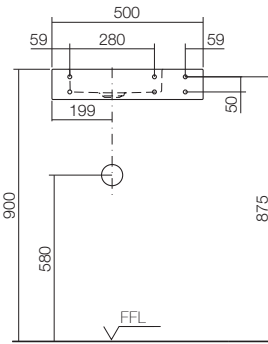

WT.XS500.R
No. 4293 000 000

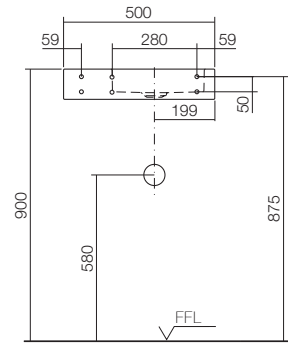

WT.QS325H
No. 4277 000 000

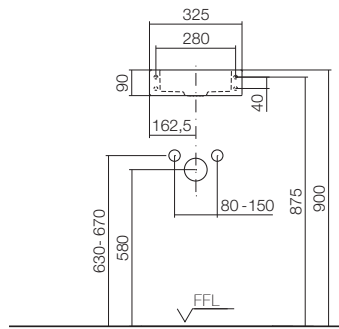

WT.QS325
No. 4270 000 000

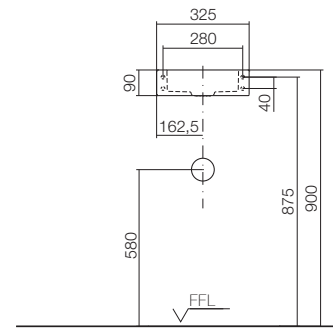

WT.QS325X
No. 4271 000 000 – Visible drain

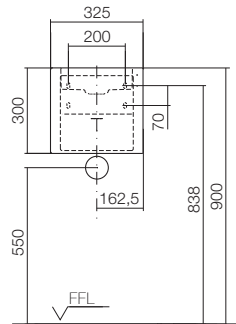

WT.QS325X
No. 4271 000 000 – Covered drain

We recommend:
Viega chrome-plated
pipe siphon for bidet
modell 5535
product no. 103781
Firma Viega

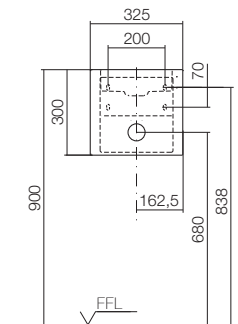

WT.QS525H.L
No. 4279 000 000

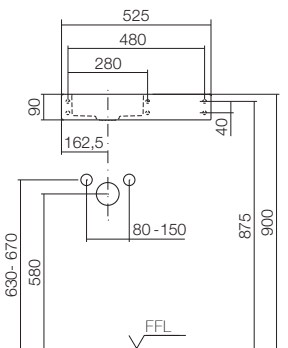

WT.QS525H.R
No. 4280 000 000

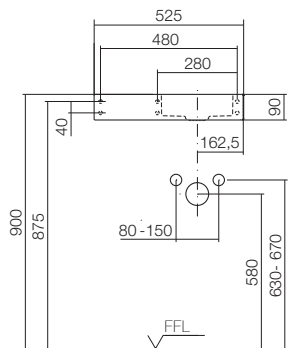

WT.QS525.L
No. 4273 000 000

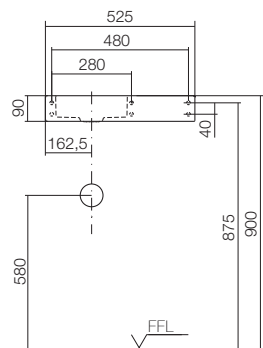

WT.QS525.R
No. 4274 000 000

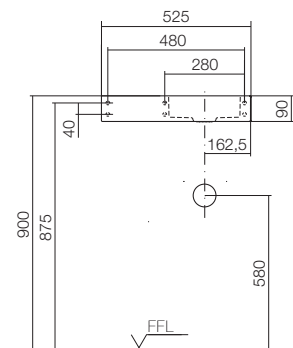

Mounting and connection measurements

WT.SR800H.R
No. 4282 600 000

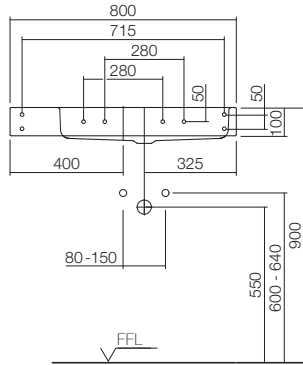

WT.SR800H.L
No. 4281 600 000

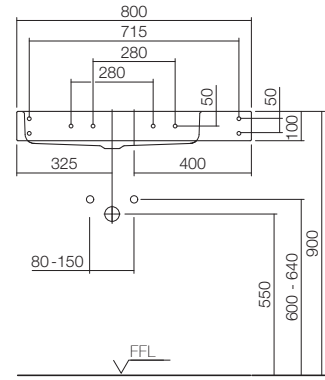

WT.PR585H
No. 4201 000 000

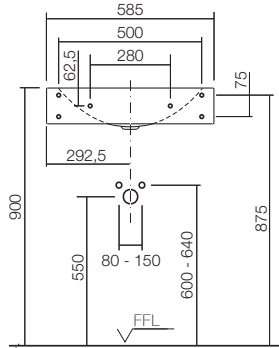

WT.PR585
No. 4200 000 000

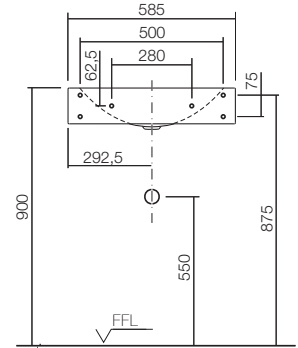

WT.PR800H
No. 4203 000 000

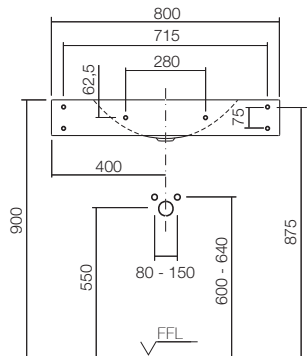

WT.PR800
No. 4203 300 000

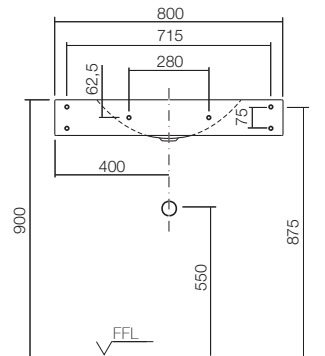

WT.PR800H.L
No. 4205 000 000

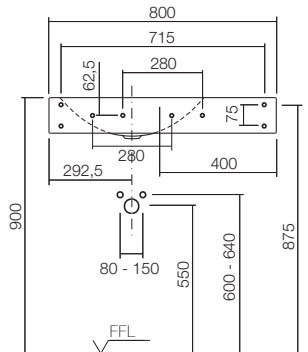

WT.PR800H.R
No. 4207 000 000

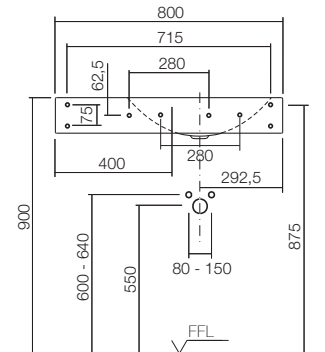

Mounting and connection measurements

WT.PR800.L

No. 4205 300 000

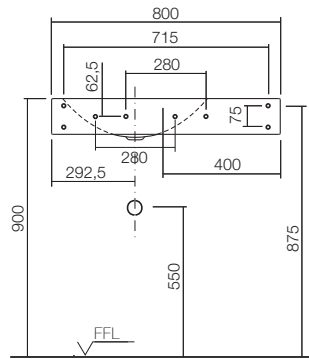

WT.PR800.R

No. 4207 300 000

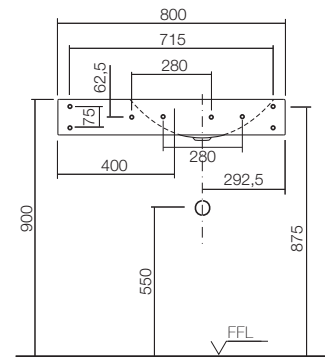

WP.Insert1

No. 5241 000 000

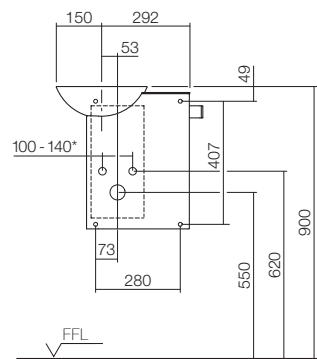

WP.Insert1

No. 5242 000 000

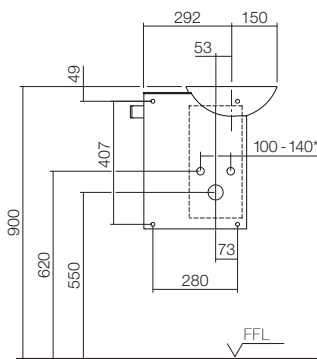

WP.Insert5

No. 5245 000 000 – connection alternatively left/right side

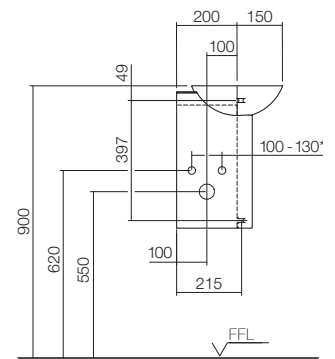
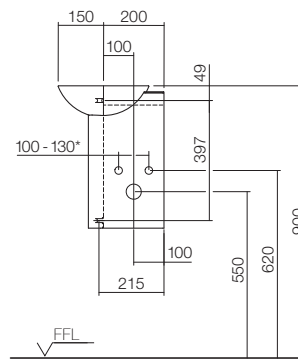

WP.PN1

No. 5256 000 XXX

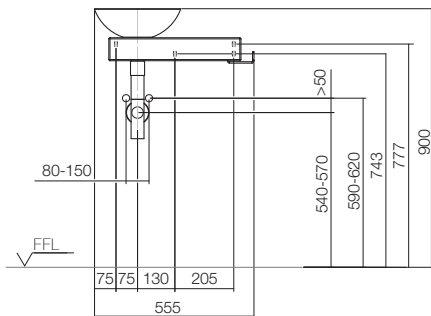

SET.WP.PN1

No. 0613 001 XXX

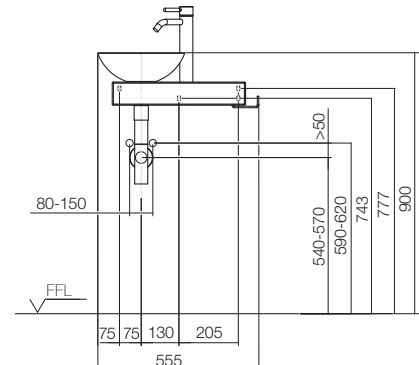

WP.PN2

No. 5257 000 XXX

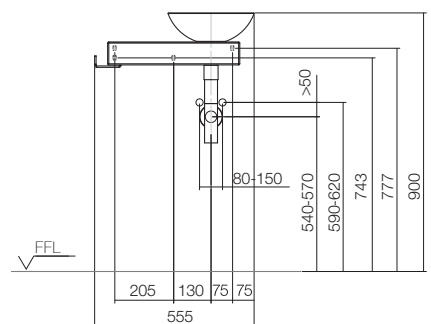

SET.WP.PN2

No. 0613 002 XXX

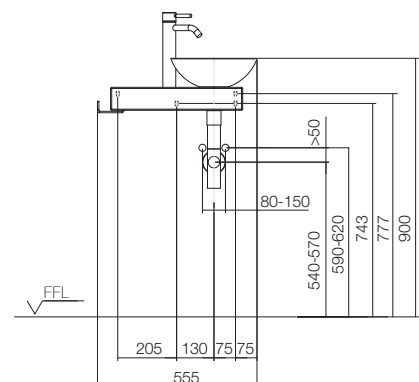

Mounting and connection measurements

WP . XXS1

No. 5062 800 000 – Visible drain

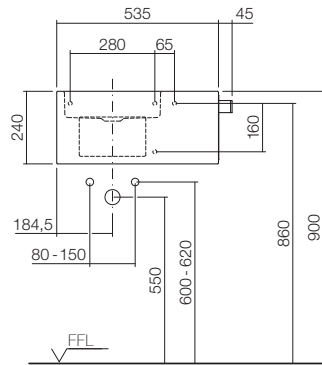

WP . XXS1

No. 5062 800 000 – Covered drain

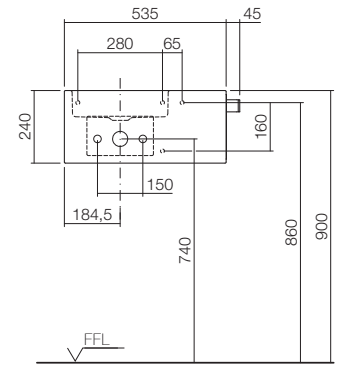

We recommend:
Viega chrome-plated
pipe siphon for bidet
modell 5535
product no. 103781
Firma Viega

WP . XXS2

No. 5065 800 000 – Visible drain

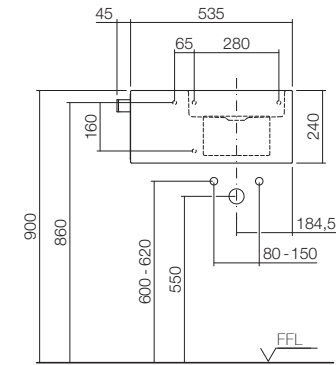

WP . XXS2

No. 5065 800 000 – Covered drain

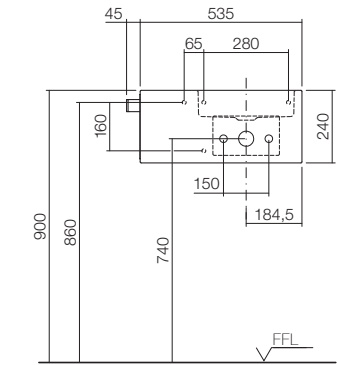

We recommend:
Viega chrome-plated
pipe siphon for bidet
modell 5535
product no. 103781
Firma Viega

WP . XS1

No. 5072 800 000 – Visible drain

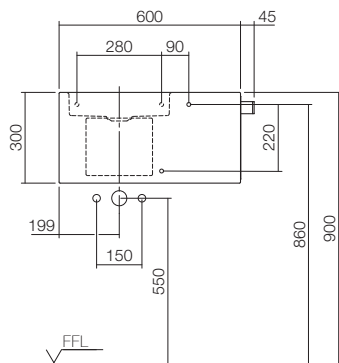

WP . XS1

No. 5072 800 000 – Covered drain

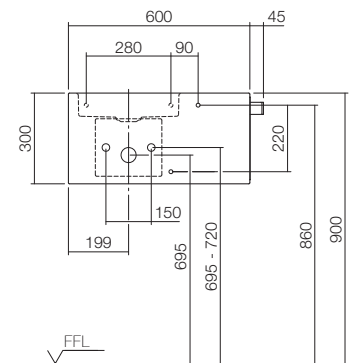

We recommend:
Viega chrome-plated
pipe siphon for bidet
modell 5535
product no. 103781
Firma Viega

WP . XS2

No. 5075 800 000 – Visible drain

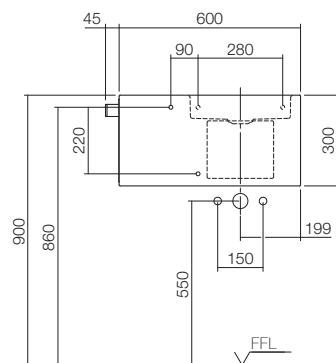

WP . XS2

No. 5075 800 000 – Covered drain

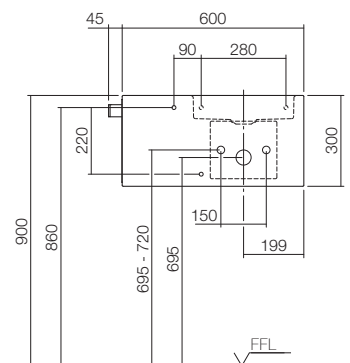

We recommend:
Viega chrome-plated
pipe siphon for bidet
modell 5535
product no. 103781
Firma Viega

Mounting and connection measurements

WP . S19 . 1
No. 5260 000 000

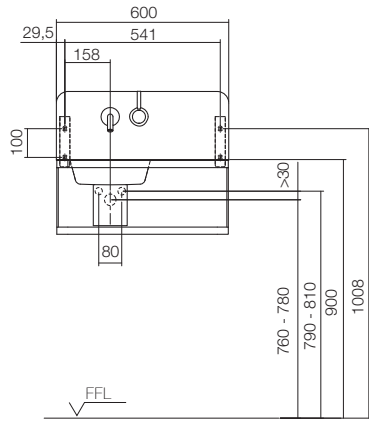

WP . S19 . 1R
No. 5266 000 000

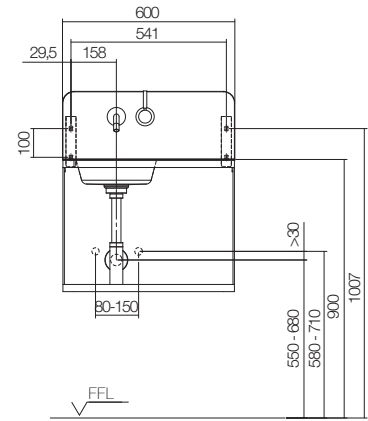

Depending on the mounting height of angle valves, an on-site adaption (tap extension 100mm) or an extension of pressure hoses will be necessary.

WP . S19L . 1
No. 5261 000 000

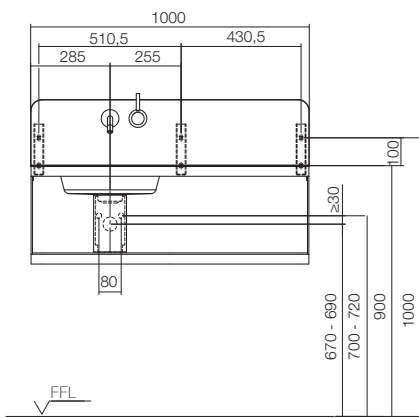

WP . S19L . 1R
No. 5267 000 000

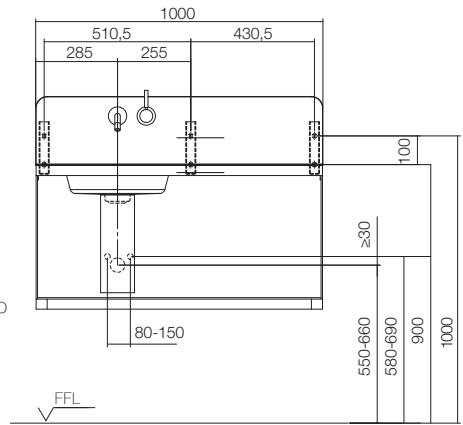

Depending on the mounting height of angle valves, an on-site adaption (tap extension 100mm) or an extension of pressure hoses will be necessary.

WP . S19L . 2
No. 5262 000 000

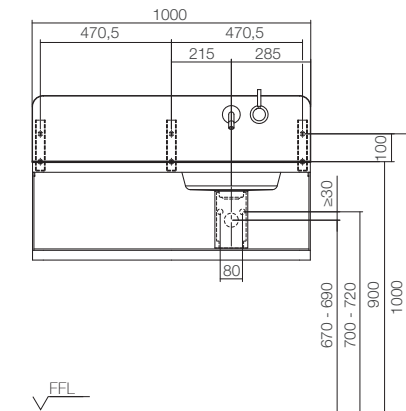

WP . S19L . 2R
No. 5268 000 000

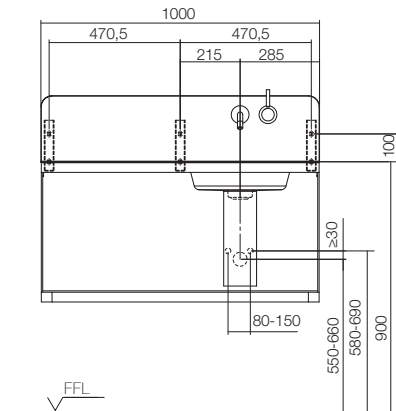

Depending on the mounting height of angle valves, an on-site adaption (tap extension 100mm) or an extension of pressure hoses will be necessary.

WP . WF20 . 1
No. 5271 000 000

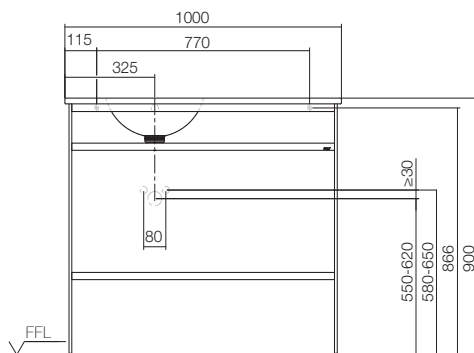

with SV.WF20.1.2
8113 000 980

WP . WF20 . 1
No. 5271 000 000

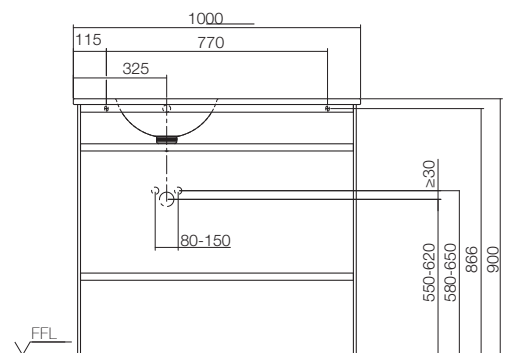

For renovation with
SV.WF20.1R /
8113 999 980

Mounting and connection measurements

WP.WF20.2
No. 5272 000 000

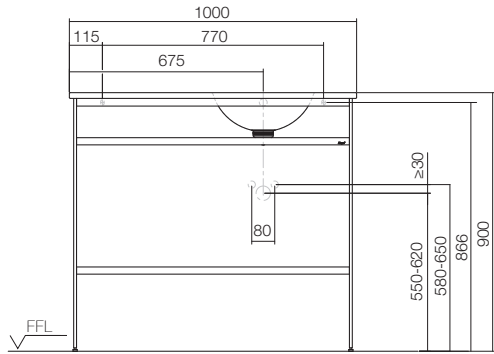

with SV.WF20.3.4
8113 000 980

WP.WF20.2
No. 5272 000 000

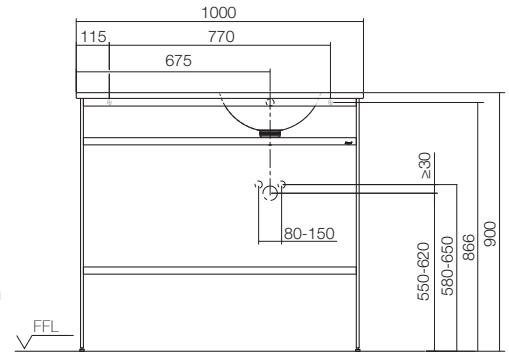

For renovation with
SV.WF20.1.2R
8113 999 980

WP.WF20.3
No. 5273 000 000

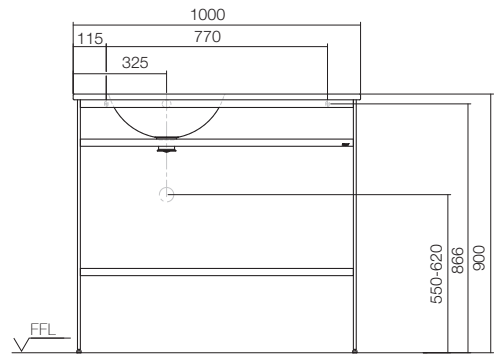

with SV.WF20.3.4
8114 000 980

WP.WF20.4
No. 5274 000 000

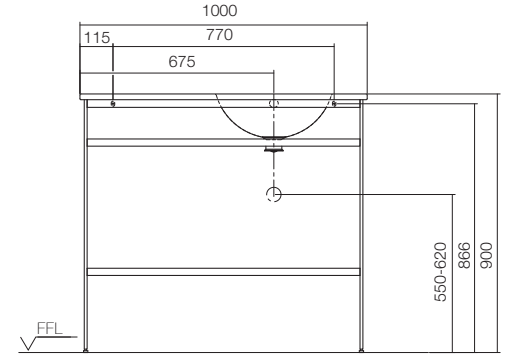

with SV.WF20.3.4
8114 000 980

WP.WF100.1
No. 5270 000 000

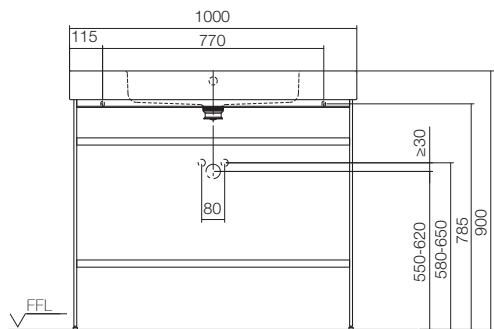

with SV.WF100.1
8112 000 980

WP.WF100
No. 5270 000 000

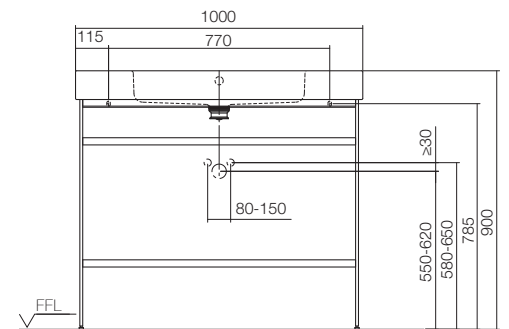

For renovation with
SV.WF100.1
8112 999 980

WP.Folio11
No. 5161 8XX 000

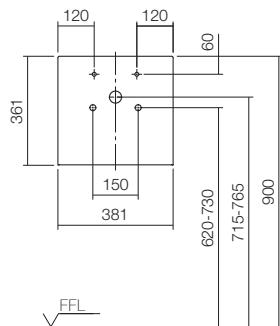

WP.Folio12
No. 5161 5XX 000

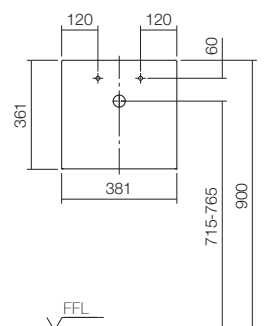

Mounting and connection measurements

WP.Folio1

No. 5155 8XX 000

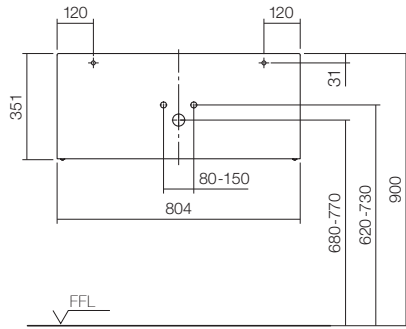

WP.Folio2

No. 5155 5XX 000

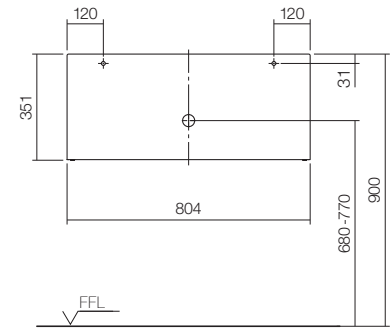

WP.Folio3

No. 5156 8XX 000

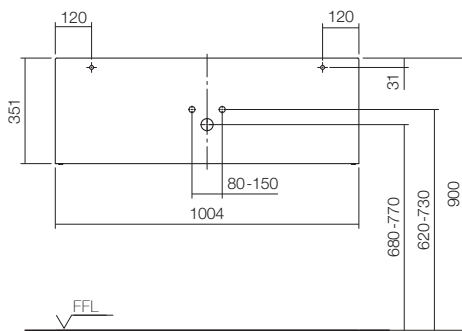

WP.Folio4

No. 5156 5XX 000

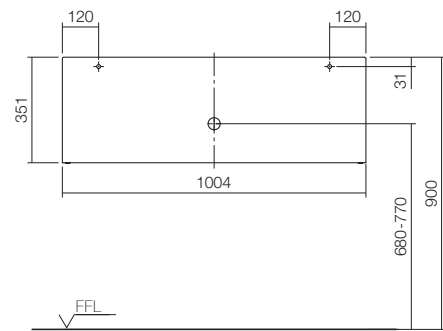

WP.Folio5

No. 5157 8XX 000

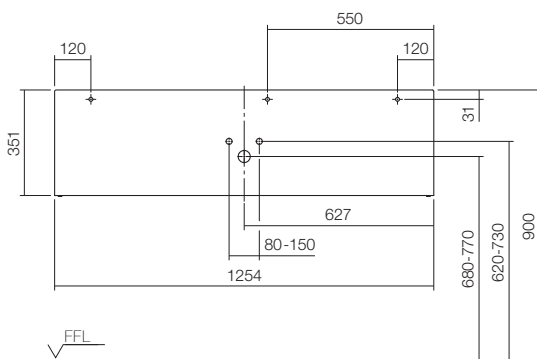

WP.Folio6

No. 5157 5XX 000

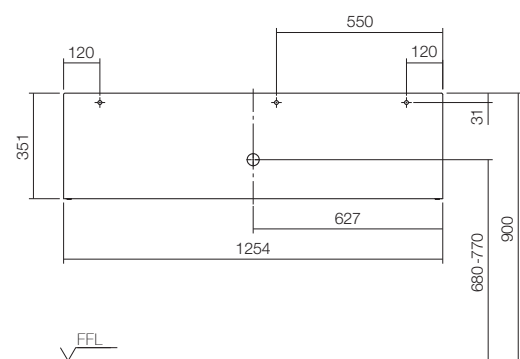

WP.Folio7

No. 5158 8XX 000

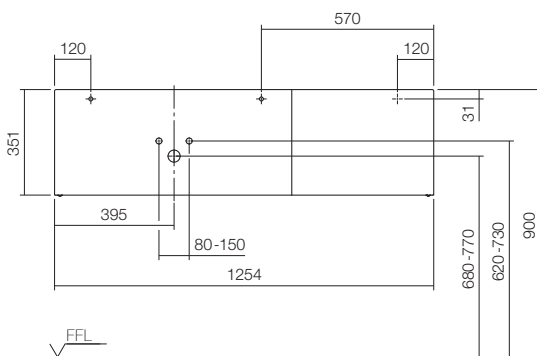

WP.Folio8

No. 5158 5XX 000

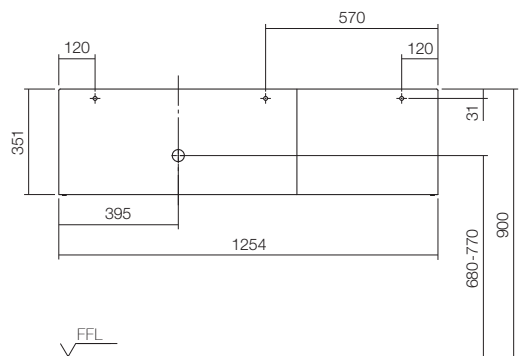

Mounting and connection measurements

WP.Folio9
No. 5159 8XX 000

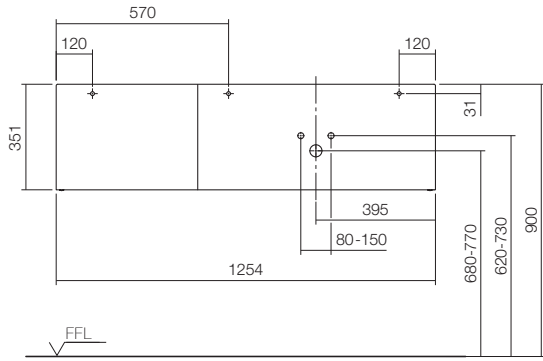

WP.Folio10
No. 5159 5XX 000

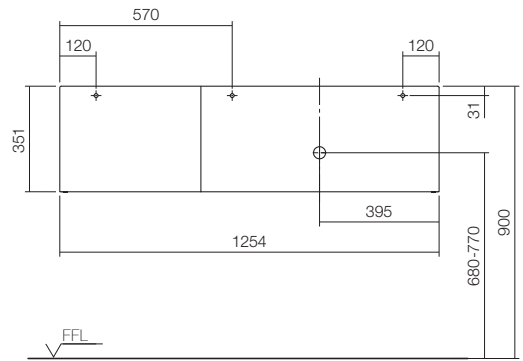

SET.WP.Insert1
No. 0637 00X 000

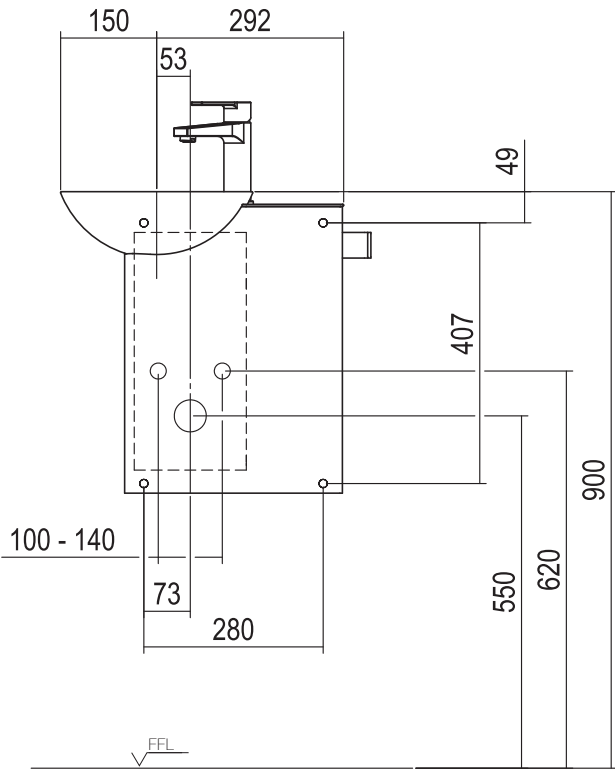

SET.WT.XS500H.L
No. 0639 00X 000

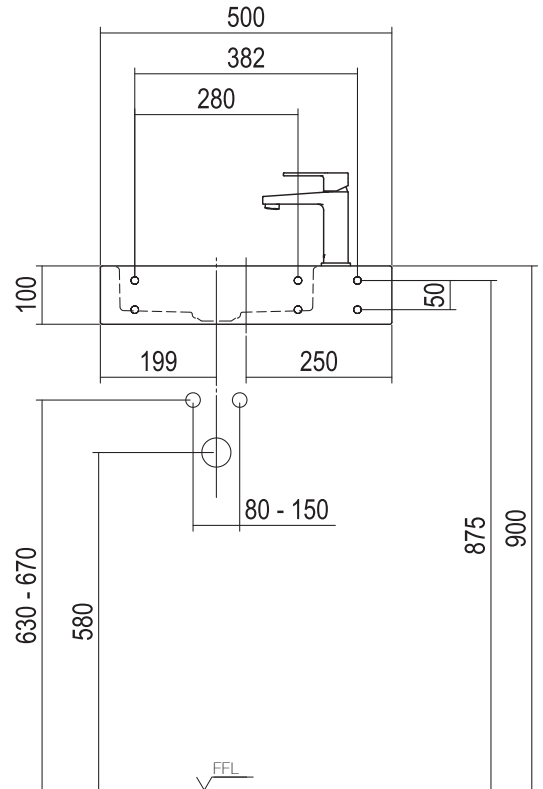

Terms of Trading and Delivery

Terms and Conditions of Sale, Delivery and Payment

1. GENERAL

1.1. The following terms apply exclusively to all of our quotations, sales and deliveries. We do not accept purchaser's terms of business that conflict with or differ from our Terms and Conditions, unless we have expressly agreed to them in writing. Differing arrangements apply only to a specific contract and not to subsequent contracts, save where expressly otherwise agreed.

1.2. All agreements, subsidiary agreements and contractual amendments must be made in writing. This applies equally to any revocation of this clause governing written form. To be effective, verbal or written agreements deviating from our contractual conditions and/or the order confirmation must be approved by the proper number of directors or authorised officers. Neither our office staff nor field staff are authorised to make differing agreements or to grant special terms.

2. INFORMATION, ADVICE

All information and advice given in respect of our products is based on our previous experience. Figures quoted are average values found from such experience. Any information or advice provided does not obviate the need for the goods supplied to be tested for suitability nor for compliance with processing instructions. Any information given verbally is not binding.

3. QUOTATION, CONTRACT SIGNATURE

3.1. All quotations are made subject to contract. A supply contract or any other contract becomes binding on us only when we have confirmed the customer's order or other order in writing or have delivered the goods.

3.2. Samples and trial items are supplied without obligation as goods on approval. Where a purchase is made based on samples and/or trial items it is made subject to deviations standards in the industry and within normal manufacturing tolerances. Unless expressly specified in the order confirmation, the supply of samples or trial items is not linked with any guarantee of quality or service life.

3.3. Samples and trial items are to be returned to us in perfect condition within 4 weeks. If they are not returned within this period, we shall be entitled to charge the list purchase price. Price lists are available on request at any time.

3.4. Save where expressly agreed otherwise, the information provided by us in text or illustrated form (e.g. descriptions, illustrations or drawings) in catalogues, brochures or other publications conclusively defines the quality of the goods we supply and their potential applications. The information we provide is not a guarantee of service life or quality and is based on our current understanding. We accept no liability for successful use of goods supplied.

3.5. Measurements in quotations and brochures are only approximate and apply subject to standard tolerances with enamel goods. All goods are subject to changes in construction made for product development purposes.

4. PRICES

4.1. The prices charged are the prices stated in our binding price list applicable on the day of delivery, save where a fixed price has been expressly agreed in writing.

4.2. All prices are net and exclusive of VAT, which is to be paid by the purchaser at the prevailing statutory rate.

4.3. If there is any increase in our sundry material procurement costs, energy costs or labour costs/incidental wage costs between the date of order confirmation and the date of delivery, we shall be entitled to adjust an agreed fixed price accordingly. The purchaser will be entitled to cancel the contract if the price rise exceeds 5%.

5. DELIVERY

5.1. The delivery periods will begin on the date of our order confirmation, but not before any agreed down payment has been received and not before all of the order details have been finally clarified, the requisite certificates procured and/or all necessary documents provided. The delivery date is deemed to have been met if the subject goods have left our factory or warehouse before this period has expired, or have been notified as ready for delivery if the goods cannot be forwarded on time for reasons beyond our control. Delivery dates are deemed to be approximate where there is no provision to the contrary.

5.2. When a delivery date not expressly designated as 'fixed' in the order confirmation is overrun, the purchaser may set a reasonable extension period for delivery. We can only be in default on expiry of this extension period.

5.3. Without prejudice to our rights arising out of delays in payment by the purchaser, delivery dates will be extended by the period of time that the purchaser fails to honour his obligations to us.

5.4. The right remains for the purchaser to arrange proper and timely delivery himself, as long as we are in no way to be liable for such non-standard delivery.

5.5. Unforeseen, exceptional circumstances beyond our control, such as in-

dustrial action, operational breakdown, government action, transport disruption or other instances of force majeure, irrespective of whether we or our suppliers are affected by such circumstances, will exempt us from our obligations under the relevant contract, although hindrances of a temporary nature shall do so only for the duration of the hindrance and a reasonable start-up time thereafter. The above circumstances are also beyond our control if they arise during a delay that has already occurred. If as a result, delivery subsequently becomes impossible or unreasonable for one of the parties, either party will be entitled to terminate the contract.

5.6. We shall not be liable for any loss due to delays arising from any breach of our contractual obligations caused by minor negligence, save where such a breach leads to injury to life, bodily harm or impaired health. There is no connection between this provision and any change in the burden of proof to the disadvantage of the purchaser.

5.7. Should liability for loss due to delay arise not only from a breach of contractual obligations caused by minor negligence, the purchaser shall, subject to the exclusion of further claims, be entitled only to claim compensation amounting to 0.5% for each full week of delay, up to a maximum of 5 percent in total, of the value of that part of the total delivery that, due to the delay, cannot be used on time or for its contractual purpose.

5.8. We shall be entitled to make part deliveries where acceptable to the purchaser. Part deliveries may be invoiced separately.

6. FORWARDING, TRANSFER OF RISK

6.1. Delivery will be ex works (Goslar), unless otherwise agreed. If Inco-terms have been agreed as the delivery terms, the version applicable on the date of contract signature shall apply.

6.2. If, at the purchaser's request, the goods have been forwarded to a place other than the place of performance, the purchaser will meet all costs thereby incurred. The choice of transit route and carrier will be at our discretion. We and the carrier must be notified in writing by the purchaser of the type and extent of any transit damage immediately upon receipt of the goods. Goods will only be insured against damage, loss or breakage in transit at the purchaser's express request and at his expense.

6.3. Forwarding and transportation are always at the purchaser's risk when goods are supplied ex works. This is also applicable if we make delivery to a third party (drop shipment deliveries) and when goods or empties (reusable packaging) are returned. Even when part deliveries are made, the risk passes to the purchaser as soon as the consignment has been transferred to the carrier or has left our warehouse for forwarding or, in the case of delivery ex works, has left our plant.

6.4. If forwarding is delayed due to circumstances for which the purchaser is responsible, or if the purchaser himself is arranging transportation, risk will pass to the purchaser on notification that the goods are ready for despatch. The purchaser must meet storage charges incurred after risk has been transferred. The monthly storage charge for goods delivered to our factory or warehouse will be 0.5% of the invoice value. Subject to showing good reason for so doing, we reserve the right to levy higher storage charges. Once a reasonable period of time has elapsed to no effect, we shall be entitled to dispose of the goods by other means and to supply the purchaser within a reasonably extended period.

7. PAYMENT

7.1. Payments are to be made in euros (€) and must be free of all charges and postage. They must be remitted only to the bank indicated by us. Payment by cheque will be deemed to have been made only when cashed. Cheques are accepted with no obligation for timely presentation or protest.

7.2. Unless expressly agreed otherwise, payments must be made within 10 days of the invoice date at a 2% discount and within 30 days of the invoice date with no deduction. There will be no discount entitlement if previous outstanding invoices remain unpaid.

7.3. If the deadline allowed for payment is exceeded, we shall be entitled to charge interest at 8 percentage points above base (Section 247 of the German Civil Code [BGB]). All of our outstanding accounts will also become immediately due.

7.4. The off-setting of any counter-claims by the purchaser is permissible only if such counter-claims are undisputed or established in law. In the event of deficient deliveries, the purchaser may at most withhold a sum amounting to three times the cost of subsequent work to make good such deliveries. When exercising his right of retention, the purchaser agrees to pay as security the amount of the unpaid portion by bank guarantee or, at our discretion, by depositing it with a notary of his choosing.

8. RETENTION OF TITLE

8.1. All goods supplied shall remain our property (retained-title goods) pending settlement of all financial claims, made on any legal grounds whatsoever, including all future and conditional claims arising from contracts signed

Terms of Trading and Delivery

simultaneously or subsequently. The same shall apply if payments are made against specified outstanding amounts. Should there be evidence indicating that a purchaser is unable to pay or that such inability is impending, we shall be entitled to terminate the contract without notice and to demand restitution of the goods.

8.2. Any adaptation or processing of retained-title goods is done on our behalf as the manufacturer in accordance with Section 950 of the BGB without creating any obligation on our part. All such processed goods are deemed to be retained-title goods as defined in clause 8.1. If retained-title goods are processed, combined or included by the purchaser with third party goods, we shall be entitled to co-ownership of the new goods to the ratio of the invoice value of the retained-title goods to the other goods used. Should our right of title become void as a result of such combination or inclusion, the purchaser agrees with immediate effect to assign to us his title or expectant rights in the new goods or object to the extent of the invoice value of the retained-title goods and to retain same on our behalf at no charge. The co-ownership rights at issue shall be deemed to be retained-title goods as defined in clause 8.1.

8.3. The purchaser may sell on, process or combine the retained-title goods with other items or otherwise install them (resale) only as part of his normal business activities and as long as he is not in default. He shall not be entitled to dispose of the retained-title goods in any other way. We must be informed immediately of any third party seizure of or other access to the retained-title goods.

8.4. The purchaser agrees with immediate effect to assign to us his receivables arising from the resale of the reserved-title goods. These shall serve as security to the same extent as the retained-title goods. The purchaser will only be entitled and authorised to resell goods on the assurance that all receivables becoming due to him as a result will be transferred to us.

8.5. If the retained-title goods are sold by the purchaser at an inclusive price together with third party goods, the receivables arising from such sale shall be assigned to us in the amount of the invoice value of the retained-title goods sold in each instance.

8.6. If the receivable amount assigned is included in a current account, the purchaser hereby assigns to us a part of the balance corresponding to the amount of the receivable sum inclusive of the final balance from the current account.

8.7. The purchaser will be entitled to collect such receivables on our behalf until such time as we revoke this right. We shall be entitled to revoke this right if the purchaser fails to meet his payment obligations arising from his business transactions with us or if we become aware of circumstances likely to lessen substantially the purchaser's creditworthiness. If the conditions are such that we wish to exercise our right of revocation, the purchaser must on request inform us forthwith of the receivable sums assigned and the debtors to which these apply, provide all information necessary to collect such debts, hand over to us all associated documents and notify the debtor of the assignment.

8.8. Our assertion of retention of title shall not constitute revocation of the contract unless we expressly state this in writing. The purchaser's right to own the retained-title goods shall lapse if he fails to perform his obligations under this or any other contract.

9. LIABILITY FOR FAULTY GOODS

9.1. We do not accept liability for unsuitable or improper use, particularly excessive stress, faulty assembly or faulty operation by the purchaser or third parties, natural wear and tear, faulty or negligent usage or handling, particularly by untrained staff.

9.2. The purchaser agrees to inspect all deliveries carefully for completeness and adequacy immediately upon receipt – even if samples or trial items were previously supplied. The delivery is deemed to have been accepted if a deficiency has not been reported by letter, telex or fax within 10 working days of the goods arriving at their destination, or, if the deficiency could not be found during due inspection, within 10 working days of discovering same. This also applies to multiple deliveries. A multiple delivery is deemed to have been accepted if no complaint is lodged within 10 days of the goods arriving at their destination. Our field staff are not authorised to acknowledge quantity or deficiency complaints.

9.3. A purchaser accepting faulty goods knowing them to be defective shall only be entitled to the claims and rights in respect of deficiencies if he reserves the right to these by reason of deficiency on acceptance.

9.4. We guarantee to meet the purchaser's claims in respect of defective goods for a period of two years, starting in each instance with the date of delivery. This shall not affect liability for defects of title as defined by statutory provision. Liability for losses arising from defects shall be governed by clause 10.

9.5. Where there are valid grounds for complaint, the purchaser shall initially only have a claim for defects to be made good, which we may effect as we see fit either by repair or by supplying a defect-free item. If such remedial action fails to work, is unacceptable to the purchaser (Section 440 of the BGB) or

superfluous to his requirements, the purchaser shall immediately have the right to reduce the purchase price or, if he so chooses, to revoke the contract or to demand damages in place of any work or reimbursement of wasted expenditure in accordance with clause 10, because:

a) we ultimately decline to make good,
b) we do not effect the make-good work on a contractually agreed date or within a specific period and in the contract the purchaser has contractually tied his continued interest in the execution of the contract to the timely provision of services, or

c) there are special circumstances, which, when considering the interests of both parties, justify immediate cancellation (Section 323, para. 2 of the BGB).

9.6. Where we deem it necessary to effect repairs or replacement deliveries, the purchaser shall allow us sufficient time and opportunity for such repairs or replacement deliveries, failing which our liability for the deficiency shall be deemed to have been discharged. Only in urgent cases where operational safety is endangered or in order to avoid disproportionately large losses, in which case we must be informed immediately, or if we are late in rectifying the defect, shall the purchaser have the right to rectify the defect himself or to have it rectified by others and then to claim reimbursement of the necessary costs from us.

9.7. The warranty period for the goods replacing a faulty item will also be two years. It will run at least until the expiry date of the original warranty period for the goods supplied.

9.8. Any manufacturer guarantees given by us are regulated in the applicable guarantee conditions. These can be viewed at www.alape.com.

10. LIABILITY FOR DAMAGES

10.1. We accept liability for damages arising from injury to life, bodily harm or impaired health in accordance with statutory provisions.

10.2. Our liability for breach of duty and our non-contractual liability shall, moreover, be limited to wilful intent and gross negligence. Liability for gross negligence of our employees, staff and vicarious agents is hereby excluded.

10.3. Breaches of material contractual obligations (cardinal duties) are excluded from clause 10.2. In such instances, even in cases of only minor negligence, we shall be liable for own negligence and that of our employees, staff and vicarious agents.

10.4. Liability is restricted to the typical contractual losses which we could have expected at contract signature based on the circumstances known to us at that time.

10.5. Any further liability is excluded, irrespective of its legal basis. In particular, we will not accept liability for lack of commercial success, loss of profits, consequential loss, losses as a result of defects or losses arising from third party claims.

10.6. The aforementioned limitations on liability apply equally to claims for reimbursement of wasted expenditure (Section 284 of the BGB).

10.7. Claims against us for damages on any legal grounds whatsoever shall lapse within two years of statutory commencement of the period of limitations and in any case no later the date of delivery of the item.

10.8. There is no shift in the burden of proof to the disadvantage of the purchaser connected with the above provisions.

10.9. Claims for compensation under the Product Liability Act remain unaffected.

11. RETURNED GOODS

11.1. Goods may only be returned by prior arrangement and must be sent carriage paid.

11.2. We charge a handling fee for returns of 30% of the net value of the goods, plus any reprocessing costs.

12. PLACE OF EXECUTION, JURISDICTION, APPLICABLE LAW

12.1. The place of execution for all obligations of both parties to this contract shall be Goslar.

12.2. Any disputes involving registered trade operators shall exclusively be settled before a competent court of law having jurisdiction for our headquarters. We shall, however, also be entitled to bring actions against the purchaser in other jurisdictions.

12.3. The relationship between ourselves and the purchaser shall be governed by German law with the exception of the United Nations Convention on the International Sale of Goods (CISG) and the provisions of international private law.

12.4. Should subsequent circumstances cause individual provisions of these Terms and Conditions to be or become invalid, this shall not affect the validity of the remaining provisions.

Imprint

Publisher Alape GmbH Goslar/Germany

Graphics Heine/Lenz/Zizka Projekte GmbH, Frankfurt/Berlin

Printing Meinders & Elstermann, Belm/Germany

Design Partner busalt design, Holzminden/Germany - Wolfgang Hartauer, London/Great Britain - sieger design, Sassenberg/Germany

Reprinting or reproduction of this manual or extracts thereof, irrespective of the method used, is only permitted with the consent of the manufacturer. If you require a components manual, we would be pleased to provide you with one.

Subject to model, programme and technical changes, as well as errors.

The General Terms and Conditions of Alape GmbH apply (see www.alape.com).

All previous Product Lists become invalid with the publication of this Product List.

The Product List is valid from the 1st of January 2023.

Art.No. 0164 000 023

Colour matrix – Glossy and matt colours

Standard colour

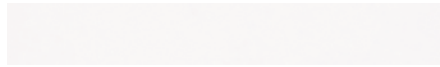

000 Alpin-white

Glossy colours

Surcharge 30% of the gross list price of the model.



156 Grey

201 Black

Matt colours

Surcharge 30% of the gross list price of the model.



004 Matt white

154 Matt grey

240 Matt black

UB Undermount basins / EB Built-in basins / HB Semi-recessed basins															
Mould	S, K, O, R			Sondo		Q		RE		Stream		ME (3mm)		KE (3mm)	
Basin type	UB	EB	HB	UB	EB	UB	EB	UB	EB	UB	EB	UB	EB	UB	EB
Grey 156	X	X	X	X	X	X	X	X	X	X	X	-	-	X	X
Black 201	X	X	X	X	X	X	X	X	X	X	X	X	X	X	X
Matt white 004	X	X	X	X	X	X	X	X	X	X	X	X	X	X	X
Matt grey 154	X	X	X	X	X	X	X	X	X	X	X	-	-	X	X
Matt black 240	X	X	X	X	X	X	X	X	X	X	X	-	-	X	X

AB Sit-on basins / SB Dish basins													
Mould	K	R	K	O	CO	Sondo	Q	RE	Stream		ME (3mm)	KE (3mm)	
Basin type	AB	AB	SB	SB	SB	AB	AB	AB	AB	SB	AB	AB	
Grey 156	X	-	X	X	X	X	-	-	-	X	X	X	
Black 201	X	X	X	X	X	X	-	-	X	X	X	X	
Matt white 004	X	X	X	X	X	X	-	-	X	X	X	X	
Matt grey 154	X	-	X	X	X	X	-	-	-	X	-	X	
Matt black 240	X	-	X/SP*	X	X	SP*	-	-	-	SP*	-	X/SP*	

WT Washstands															
Mould	IC, MC	K	CO	CO	RS	QS		RE	PR	GR	Stream	XS	XXS	WT.RX...KE	
Basin type	WT	WT.RX	WT	WT.RX	WT	WT	WT.RX	WT	WT	WT	WT	WT	WT	Basin	Pillar
Grey 156	-	o.r.	X	X	X	o.r.	o.r.	-	-	-	-	-	-	X	X
Black 201	X	X	X	X	X	o.r.	o.r.	-	X	X	X	X	X	X	X
Matt white 004	X	X	X	X	X	o.r.	o.r.	-	X	X	X	-	X	X	X
Matt grey 154	-	X	X	X	X	o.r.	o.r.	-	-	-	-	-	-	X	X
Matt black 240	-	X	X	X	X	o.r.	o.r.	-	-	-	-	-	-	X	X

UB – Undermount basin EB – Built-in basin HB – Semi-recessed basin AB – Sit-on basin SB – Dish basin WT – Washstand

SP: Serial product X: available in this colour - : not available in this colour o. r. : on request

Pillar washstand

If a matt colour is chosen, the wall bracket of the pillar washstands is either matt white or matt black, thus varying from the colour of the pillar.

- matt white wall bracket if the colour is: matt white.
- matt black wall bracket if the colour is: black/grey/matt black/matt grey

Please note:

- Special colours on request
- * In the chapter Special glazes you will find series products in matt black as well as other products in different colors and surfaces

Alape GmbH
Am Gräbicht 1-9
38644 Goslar
Germany

Postfach 2812
Deutschland

Tel +49 (0)5321 558 0
Fax +49 (0)5321 558 400
export@alape.com

Service Hotline
Tel +49 (0)5321 558 111

www.alape.com

Dornbracht Austria GmbH
IZ NÖ Süd, Straße 7
Objekt 58D, Top 6
2355 Wiener Neudorf
Österreich

Tel +43 (0)1417 06 90
at@dornbracht.com